

Twin Wall Spot

PROJECT:
TYPE:
SOURCE:
NOTES:

PURELED SPECIFICATIONS PER HEAD

LED Chip	Cree XHP-50-2 Plug and Play field replaceable LED board
Luminaire Output	600 Lumens @ 1050mA (6 watts), 420 Lumens @ 700mA (4 watts), 240 Lumens @ 350mA (2 watts), delivered from luminaire with unobstructed beam.
Lumens Per Watt	100 Lumens minimum @ 6 watts, delivered from luminaire with unobstructed beam
CRI (3000K)	90+
Colour Temperatures	2700K, 3000K, 4000K
Beam Angles	15, 25, 38, 60
Ingress Protection	IP66
Warranty	Electronics = 5 years Body Cop/ SS = 10 years Body Aluminium = 5 years
Standards	AS/NZS 61046, EN60598 cUL 1838, 2108, 1598 CSA C22.2 No. 250.7, No. 250.0-08, No. 250.0 CE

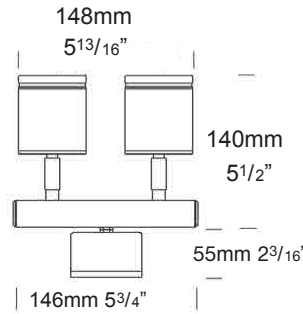
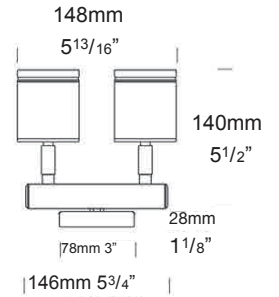

Retro

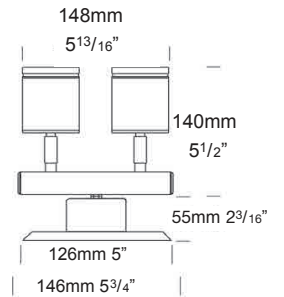

Retro USA/Canada

PRODUCT CONFIGURATION

Please fill in appropriate codes into boxes provided

Cat. No. TWS/L

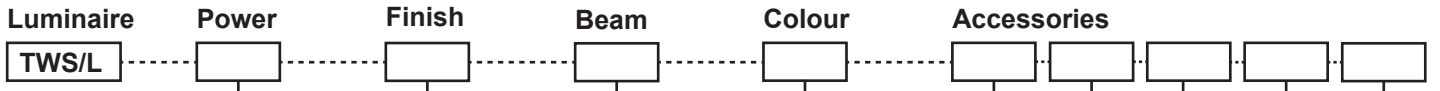

- S SERIES, REMOTE DRIVER
- D3 12VAC, 2W INTEGRAL
- D7 12VAC, 4W INTEGRAL
- D10 12VAC, 6W INTEGRAL
- R RETRO, 110/240V DRIVER

SERIES, REMOTE DRIVER REQUIRED:
Constant current driver
Individual fixtures require 12vdc @ 1050mA maximum

12VAC INTEGRAL DRIVER:
Hunza integrated plug and play driver (included)
Input: 9-15VAC.
Output: 6vdc @ D3=350mA, D7=700mA, D10=1050mA (1050mA limited to ≤ 40°C (104°F) ambient temperature in stainless steel)

110/240VAC RETRO DRIVER:
Input: 120/240vac, 5 watt total (driver included)
Output: 12vdc, 700mA
0-10 volt dimming (USA - non dimming)

- Material/Finish**
- ALUMINIUM
- EBK BLACK
 - EBZ BRONZE
 - EOGR OLIVE GREEN
 - EWH WHITE
 - EWB WHITE BIRCH
 - EDG DARK GREY
 - ESTAR SILVER STAR
 - ECT CORTEN
 - COP SOLID COPPER
 - SS STAINLESS STEEL

- Beam**
- 15 15°
 - 25 25°
 - 38 38°
 - 60 60°

- Colour**
- 2 2700K
 - 3 3000K
 - 4 4000K

- Accessories**
- HCL HEX CELL LOUVRE
 - SNT SNOOT
 - GG GLARE GUARD
 - LF FROSTED LENS
 - WBAP WALL BOX ADAPTOR
 - LKN LOCKING KNUCKLE
 - CJK CABLE JOINT KIT

OTHER LAMP OPTIONS:

- TWS/H - MR16 Halogen 12V Lamp
- TWS/SL - MR16 LED Retrofit 12V Lamp (lamps vary by market - please refer to supplier for details)
- TWS/GUH - GU10 120/240V Halogen Lamp (body length increases for all GU10 lamps)
- TWS/GUSL - GU10 LED Retrofit 120/240V Lamp (lamps vary by market - please refer to supplier for details)

[Click here for Remote Power Supply Guidance Charts](#)

[Click here for halogen specification sheet](#)

LUMINAIRE CONSTRUCTION

CNC machined from one of the following metals:

Aluminium:

Body: high corrosion resistant 63.5mm (2^{1/2}") x 10mm (3/8") aluminium.

End cap: solid aluminium 63.5mm (2^{1/2}") rod.

Base and Mounting Plate (Retro™): handspun 2mm (5/64") aluminium. Base cast from virgin CC401 low copper aluminium alloy chromate substrate and high UV resistant polyester powder coat.

Colours:

Black, Bronze, Silver Star, White, White Birch, Olive Green, Dark Grey, Corten.

Copper:

Body: 63.5mm (2^{1/2}") x 10mm (3/8").

End cap: solid copper 63.5mm (2^{1/2}") rod.

Base and Mounting Plate (Retro™): handspun 2mm (5/64") copper disk and forged brass.

316 Stainless Steel:

Body: 63.5mm (2^{1/2}") x 10mm (3/8").

End cap: solid 316 stainless steel 63.5 (2^{1/2}") rod.

Base and Mounting Plate (Retro™): investing cast and CNC machined 316 stainless steel.

Step Lens:

10mm (3/8") extra clear, low iron, shatter resistant glass.

Lifetime warranty

Gaskets:

Silicone, iron impregnated 220°C (428°F).

Knuckles:

Copper luminaires: 360° rotation and 0-90° elevation, solid brass with anti rust spring.

Stainless Steel luminaires: 360° rotation and 0-90° elevation, full stainless steel construction.

Mounting:

12 volt: the luminaire is mounted to the wall using two 316 stainless screws through a shallow base 28mm (1^{1/8}") in depth.

Retro™ (110/240-12volt): a mounting plate is fixed to the wall using two screws and the luminaire is fitted to the mounting plate.

Luminaire Weight:

Low voltage

Alum: 0.775kg (1lb 11oz)

Cop: 2.230kg (4lb 14oz)

SS: 1.750kg (3lb 13oz)

Retro™

Alum: 1.100kg (2lb 6oz)

Cop: 2.650kg (5lb 13oz)

SS: 2.200kg (4lb 13oz)

ACCESSORIES

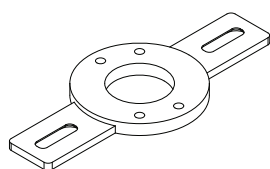

Wall Box Adaptor

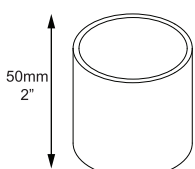

Snoot

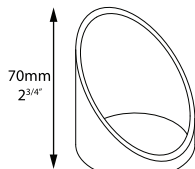

Glare Guard

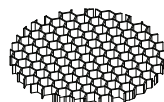

Hex Cell Louvre

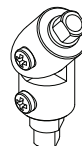

Locking Knuckle

BEAM ANGLES

High efficiency PMMA TIR lenses. Field replaceable

IES files available for download: hunzalighting.com/downloads

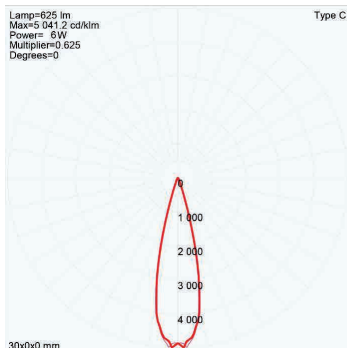

15° FWHM TIR

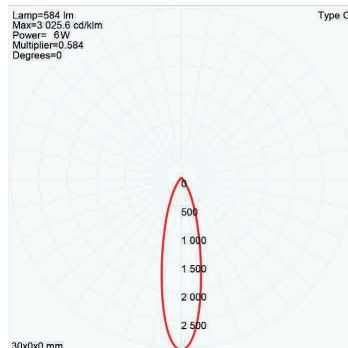

25° FWHM TIR

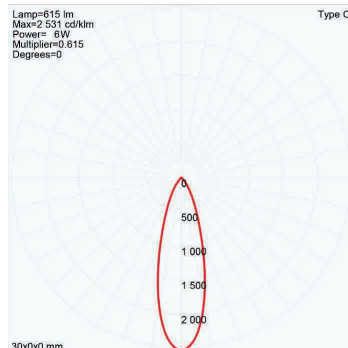

38° FWHM TIR

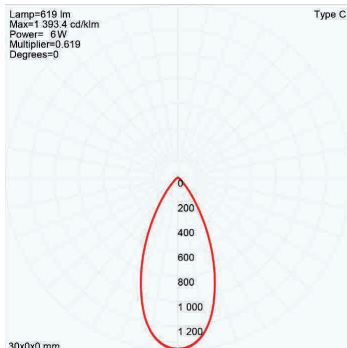

60° FWHM TIR

WIRING GUIDE

Series/remote driver

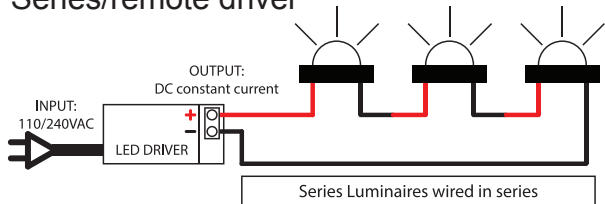

Series Luminaires wired in series

Available for download: hunzalighting.com/downloads

12v integral driver

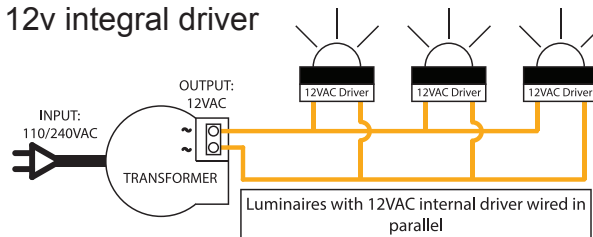

Luminaires with 12VAC internal driver wired in parallel

Diagrams are a guide only, wire colours and polarity may change depending on fixture and country

Specifications may change without notification

Aug 2017