

## Border Lite PURE LED

PROJECT:

TYPE:

SOURCE:

NOTES:

### SPECIFICATIONS

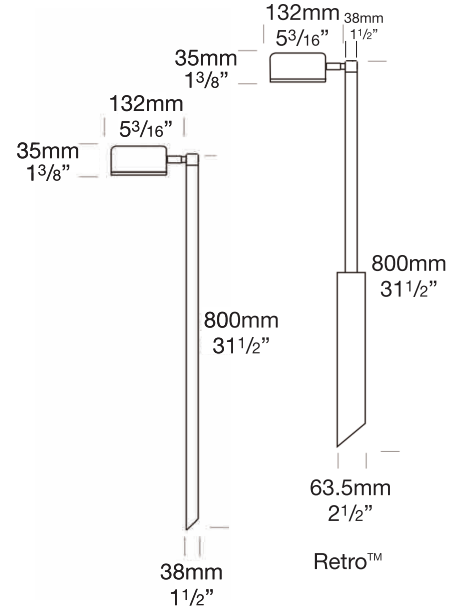

<b>LED Chip</b>	Cree XPG-3 Plug and Play field replaceable LED board
<b>Luminaire Output Per Head</b>	120 Lumens @ 700mA (2 watts), delivered from luminaire with unobstructed beam.
<b>Lumens Per Watt</b>	60 Lumens minimum @ 2 watts, delivered from luminaire with unobstructed beam
<b>CRI (3000K)</b>	85+ Standard, 90+ Optional
<b>Colour Temperatures</b>	2700K, 3000K, 4000K
<b>Beam Angles</b>	100 degrees
<b>Ingress Protection</b>	IP56/IP66

<b>Warranty</b>	Electronics = 5 years Body Cop/SS = 10 years Body Aluminium = 5 years
<b>Standards</b>	AS/NZS 61046 cUL 1838, 2108 CSA C22.2 No.250.7, No.250.0-08 CE

### PRODUCT CONFIGURATION

Please fill in appropriate codes into boxes provided

Cat. No. BL/L

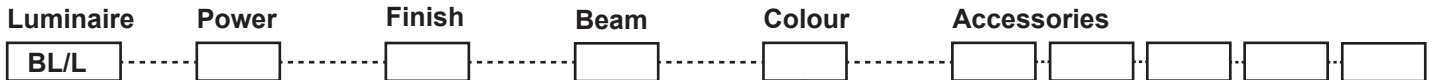

- S** SERIES, REMOTE DRIVER
- D3** 12VAC, 1W INTEGRAL
- D7** 12VAC, 3W INTEGRAL
- R** RETRO, 110/240V DRIVER

- ALUMINIUM**
- EBK** BLACK
  - EBZ** BRONZE
  - EOGR** OLIVE GREEN
  - EWH** WHITE
  - EWB** WHITE BIRCH
  - EDG** DARK GREY
  - ESTAR** SILVER STAR
  - ECT** CORTEN
  - COP** SOLID COPPER
  - SS** STAINLESS STEEL

- 2700K
- 3000K
- 4000K
- 3000K, 90+ CRI

- FLANGE MOUNT
- CLEAR LENS
- CABLE JOINT KIT

**SERIES, REMOTE DRIVER REQUIRED:**  
Constant current driver  
Individual fixtures require 3vdc @ 700mA maximum

**12VAC INTEGRAL DRIVER:**  
Hunza Buckbullet driver (included)  
Input: 12VAC, 3watt total  
Output: 3vdc @ D3=350mA, D7=700mA

**110/240VAC RETRO DRIVER:**  
Input: 120/240vac, 3 watt total (included)  
Output: 3vdc, 700mA  
0-10 volt dimming  
(USA - non dimming)

ADDITIONAL COMMENTS:

[Please click for Hunza Power Supply selection Chart](#)  
[Please click for Hunza Voltage drop Chart](#)

# LUMINAIRE CONSTRUCTION

## CNC machined from one of the following metals:

### Aluminium

Head: virgin high corrosion resistant CC401 low copper aluminium alloy, with chromate substrate and high UV resistant polyester powder coat.  
Pole: aluminium 38mm (1½") tube.

### Colours:

Black, Bronze, Silver Star, White, White Birch, Olive Green, Dark Grey, Corten.

### Copper/Solid Bronze

Head: cast from LG2 bronze.  
Pole: solid copper 38mm (1½") tube.

### 316 Stainless Steel

Head: cast from 316 stainless steel.  
Pole: 316 stainless steel 38mm (1½") tube.

### Knuckles:

Aluminium and Copper luminaires - 360° rotation and 0-90° elevation, solid brass with anti rust spring.  
Stainless Steel luminaires - 360° rotation and 0-90° elevation, full stainless steel construction.

### Lens:

3mm frosted shatter resistant glass.  
Lifetime Warranty.

### Gaskets:

Silicone, iron impregnated 220°C (428°F).

### Mounting

The pole 800mm (31½") is directly mounted into the earth or concrete.  
Flange Mount option is available for hard surfaces.

### Luminaire Weight:

Low voltage

Alum: 0.800kg (1lb 12oz)

Cop/SBZ: 1.700kg (3lb 12oz)

SS: 1.600kg (3lb 8oz)

Retro™

Alum: 2.000kg (4lb 7oz)

Cop/SBZ: 3.400kg (7lb 8oz)

SS: 3.150kg (6lb 15oz)

## ACCESSORIES

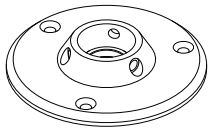

Flange Mount  
FM38 for low voltage  
FM90 for Retro

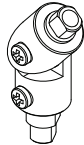

Locking Knuckle

## BEAM ANGLES

IES files available for download: <http://www.hunzalighting.com/download.php>

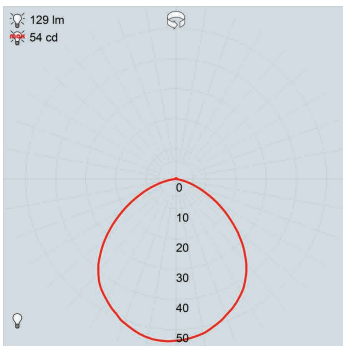

FWHM  
frosted lens

## WIRING GUIDE

### Series/remote driver

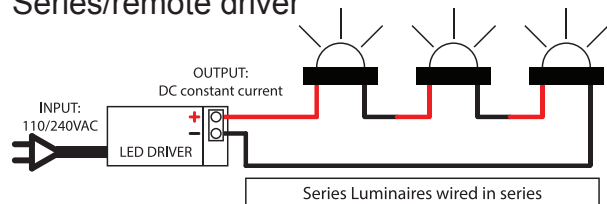

Diagrams are a guide only, wire colours and polarity may change depending on fixture and country

available for download: <http://www.hunzalighting.com/download.php>

### 12v integral driver

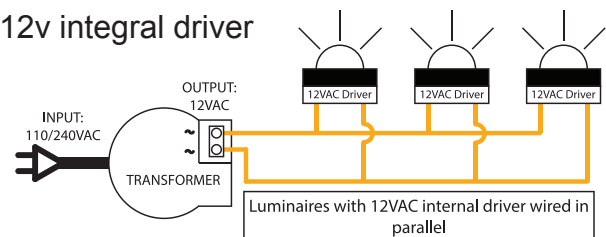

Specifications may change without notification

Aug 2017