

E-Lite Square

Cat. No. EAVESQ

Cat. No. EAVESQGU

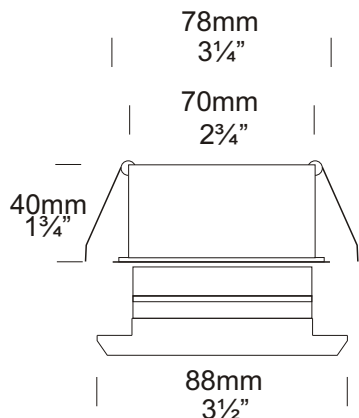

The E-Lite Square is a recessed downlight ideal for installation in eaves, soffits, entrance ways, verandahs, carports or covered decks. It can also be used in bathrooms, kitchens or where moisture transfer or decibel rating is a minimum requirement.

This luminaire is machined from a choice of solid aluminium with a UV stable powder coated finish, solid copper or 316 stainless steel with a clear, tempered, flush glass lens and high temperature silicon gaskets. The 316 stainless steel E-Lite Square is electro-polished to increase corrosion protection.

A GU10 version of this luminaire is also available for line voltage lamps.

Ordering Information

Luminaire Type	Material	Accessories
EAVESQ - E-Lite Square	BK - Black BZ - Bronze GN - Green STAR - Silver Star WH - White WB - Birch DG - Dark Grey OG - Olive Green RG - Beige PR - Primrose SS - 316 Stainless Steel COP - Copper	LENSSTEPF - Frosted Lens GU - GU10 Option

Ordering Example: EAVESQ COP - E-Lite Square in Copper.

EAVESQGU COP - E-Lite Square GU10 in Copper.

HUNZA™ PURE OUTDOOR LIGHTING

HUNZA FACTORY
 130 Felton Mathew Ave
 Glen Innes
 Auckland 1072
 New Zealand

Ph: 64-9-528 9471
 Fax: 64-9-528 9361
hunza@hunza.co.nz
www.hunza.co.nz

INTERNATIONAL CONTACTS:
www.hunza.co.nz/contacts.php

Specifications may change without notice.
 Manufactured in New Zealand.
 © 2011 Hunza Holdings Ltd.

Ver 1.4

Luminaire Construction

CNC machined from:

Aluminium body high corrosion resistant 88mm (3½") x 88mm (3½") solid aluminium rod with chromate substrate and high UV resistant polyester powder coat.

Colours Black, Bronze, Green, Silver Star, White, Birch, Dark Green, Olive Green, Beige, Primrose.

Copper body 88mm (3½") x 88mm (3½").

316 Stainless Steel body 88mm (3½") x 88mm (3½"). Electro-polished.

Canister 316 Stainless Steel

Mounting

Via canister supplied, which maintains the aesthetic look of the flange by eliminating any mounting holes in the flange. The E-Lite Square canister is designed to fit through a 70mm hole and be fixed into position by two spring clips. The luminaire is held in the canister by an O ring.

Features

Lens:

10mm (3/8") clear flush fit shatter resistant glass. A clear lens is fitted as standard.

Lifetime Warranty.

Lamp Holders:

GU5.3 & GU10 - 350°C (662°F) ceramic multi contact lamp holder with 250°C (480°F) teflon cables.

Accessories:

Frosted Lens (Cat. LENSSTEPF).
GU10 Option (Cat. GU).

Standards

IPX5, NON-UL

NZCEP 54 = CA, SCB 100mm
HBX 75mm, REC 135mm
DB = RW30

Weight

Alum 0.400 kg (14oz)
Cop 1.000 kg (2lb 3oz)
SS .950 kg (2lb 1oz)

Power Supply

HUNZA™ H20, H40 or H50
Transformer: not included.

Lamp Type

Suitable for use with Halogen
MR16 GU5.3 50 watt lamp max.
GU10 - GU10 25 or 35 watt lamp max.

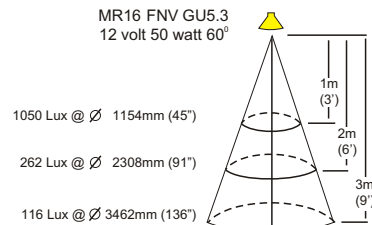
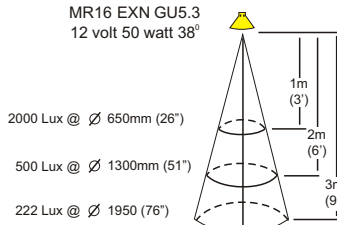
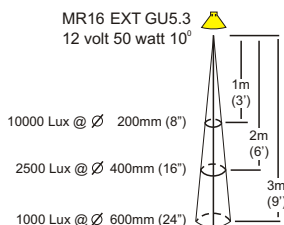
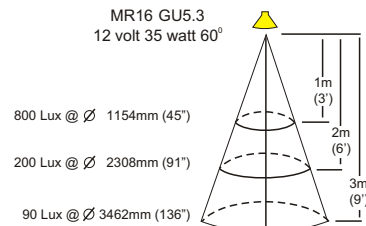
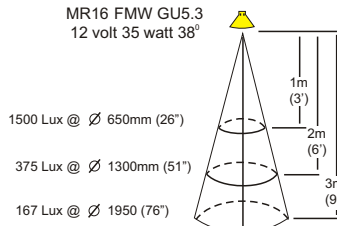
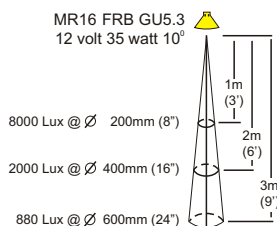
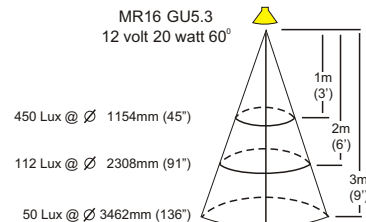
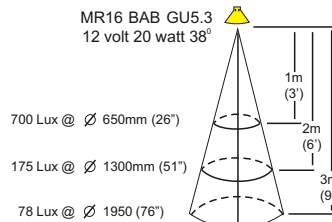
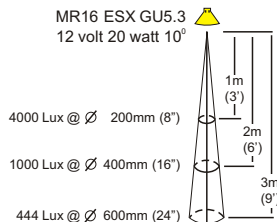

HUNZA™ PURE
OUTDOOR
LIGHTING

HUNZA FACTORY
130 Felton Mathew Ave
Glen Innes
Auckland 1072
New Zealand

Ph: 64-9-528 9471
Fax: 64-9-528 9361
hunza@hunza.co.nz
www.hunza.co.nz

INTERNATIONAL CONTACTS:
www.hunza.co.nz/contacts.php

Specifications may change without notice.
Manufactured in New Zealand.
© 2011 Hunza Holdings Ltd.

Ver 1.4