

EPTRONICS

Constant Current Driver

Cat. No. LD-25W-36-CO700-LE
LD-25W-36-CO700-TE
LD-25W-36-CO700

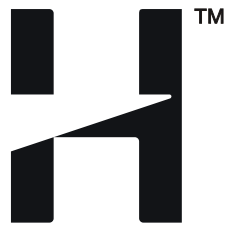
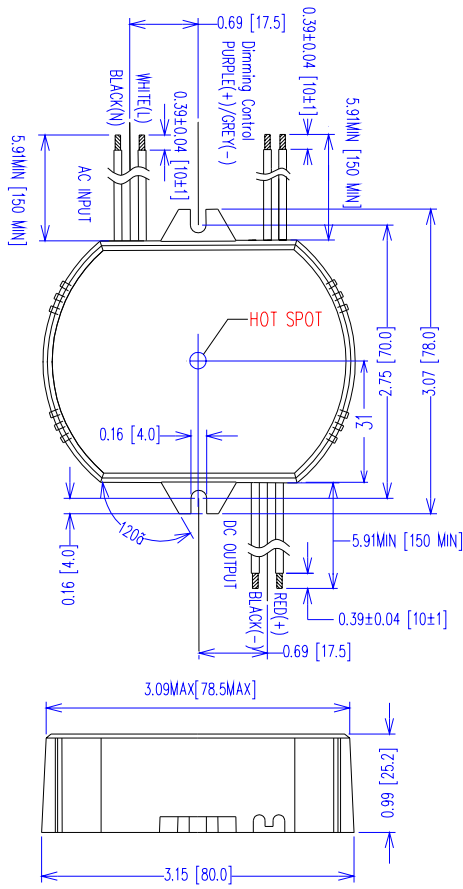

The EPTronics LD-25W-36-CO700 is a 25 Watt electronic, constant current, remote driver available to power Hunza series version PURE LED fixtures in the USA market. It is designed to be used with Triac (-LE model), ELV (-TE model) phase-cut dimmers or 0-10V dimmers (no code suffix).

For exterior use, it is highly recommended to install this in a weatherproof box, available as an option from Hunza. The PC-17-02 weatherproof box is a requirement for UL compliance.

When this driver is used as a remote power supply, SERIES WIRING is required to connect the fixtures. Please refer to the [Hunza PURE LED Series Wiring page](#) for more information on wiring diagrams and fixture loads per driver.

Electrical Specification

- Input voltage range: 90 to 305VAC
- Frequency: 47~ 63HZ
- Power Factor: > .94 at full load 115Vac/230Vac 50/60Hz
- Inrush current: <15A at 25C, 230V, cold start, Max. Load
- Input current: 0.25A at 120Vac, 60Hz, Maximum Load
- Efficiency: 84% typical at 115Vac 60Hz, 230Vac 50Hz
- Maximum output power: 25W
- Constant Current output: 700mA
- Output voltage range: 12-36 VDC

Safety and Compliance

- UL8750, EN61347, CSA 22.2 safety compliant
- FCC, 47CFR Part 15 Class B compliant
- Water resistant and Dust Proof Design: IP66, NEMA4, for Dry, Damp, Wet Locations
- Safety Isolation between Primary and Secondary
- Meets EN61000-3-2 & EN61000-3-3 Class C
- Protection: output over-voltage, output over-current, output short circuit, reset by power cycling.
- Transient protection built in.

Environmental

- Operating temperature: Tc 90°C Maximum. Reference -30 to +60°C ambient
- Storage temperature range: -40 to +85°C
- Humidity (non-condensing): 5% - 95%RH
- Cooling: Convection
- Vibration Frequency: 5-55Hz/2g, 30 minutes
- Impact resistance: 1g/s
- MTBF@ 40°C: 482,000 hours @ Full Load per MIL-217F Notice 2.



IP66



HUNZA™ PURE OUTDOOR LIGHTING

HUNZA FACTORY
130 Felton Mathew Ave
Glen Innes
Auckland 1072
New Zealand

Ph: 64-9-528 9471
Fax: 64-9-528 9361
hunza@hunza.co.nz
www.hunzalighting.com

INTERNATIONAL CONTACTS:
www.hunzalighting.com/contact.php
Specifications may change without notice.
Manufactured in New Zealand.
2016 Hunza Productions Ltd.