

Inground 1-11gm

Cat. No. IG1-11gm



The Inground 1-11gm has a fully adjustable gimble suitable for use with 50 and 75 watt MR16 lamps and is complete with a hex cell louvre and space to mount colour and lineal spread lenses. It has its own 120 or 240 volt ac integral power supply, is dimmable and is available in a 12 volt version for use with a remote power supply. The luminaire can be driven over at 10km/h max (6mph) with a maximum vehicle weight of 1500kg (3000lbs) or walked upon without damaging it and it has a 'Flush Fit' lens which stops water pooling and depositing dirt on the lens.

The Inground 1-11gm is supplied with a mounting canister. The lamp can be directed (up to 45 degrees from horizontal) without the need to remove the fitting from the canister due to the vandalresistant four allen head screw fixing system which attaches the flange to the body of the luminaire.

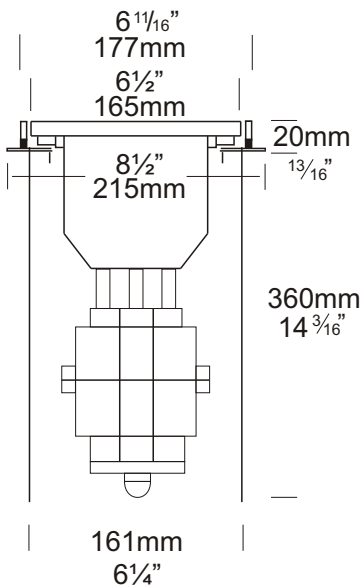

Ordering Information

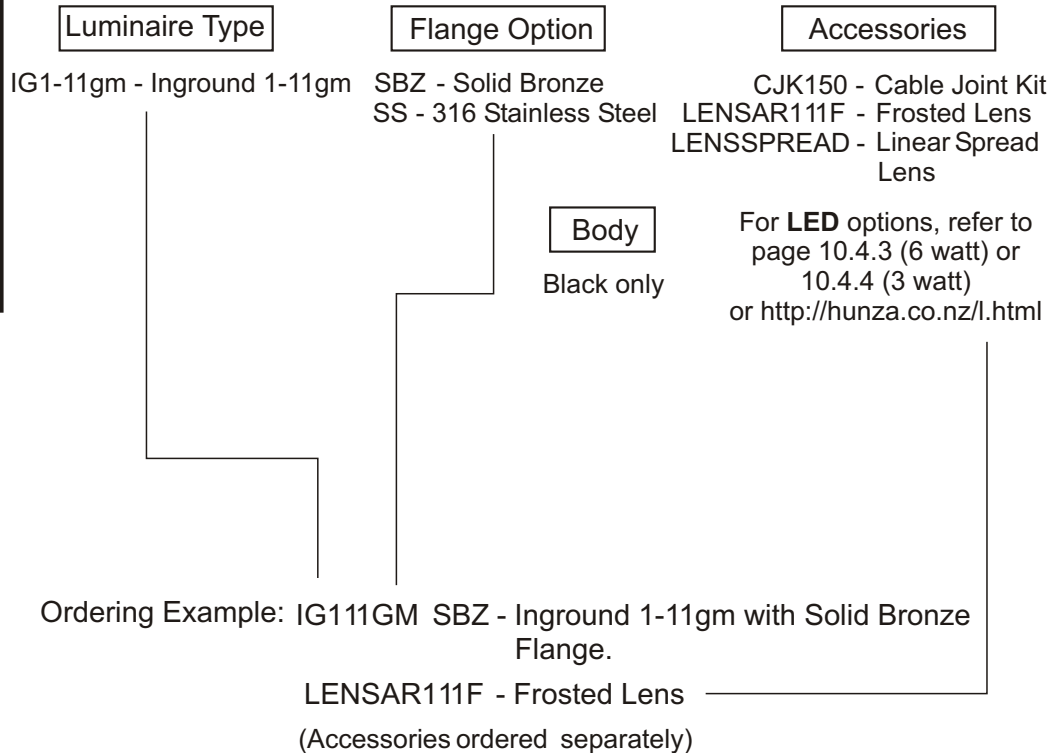

HUNZA™ PURE OUTDOOR LIGHTING

HUNZA FACTORY
130 Felton Mathew Ave
Glen Innes
Auckland 1072
New Zealand

Ph: 64-9-528 9471
Fax: 64-9-528 9361
hunza@hunza.co.nz
www.hunza.co.nz

INTERNATIONAL CONTACTS:
www.hunza.co.nz/contacts.php

Specifications may change without notice.
Manufactured in New Zealand.
© 2011 Hunza Holdings Ltd.

Ver 1.4

Luminaire Construction

Body

Cast from virgin high corrosion resistant CC401 low copper aluminium alloy, with chromate substrate and high UV resistant black polyester powder coat.

Flanges

The flange is attached to the body by four 316 Stainless Steel allen head anti vandal screws and is available in either

Solid Bronze - 170mm (6½") bar.

Solid 316 Stainless Steel - 170mm (6½") rod.

Mounting

The Inground 1-11gm is supplied with a mounting canister for casting in concrete. The fitting can be driven over or walked upon without damaging it. Maximum drive over speed 10km/h (6mph) and maximum vehicle weight 1500kg (3300lbs).

Features

Lens:

12mm (½") thick 'Flush Fit' clear tempered shatter resistant glass.

Lifetime Warranty.

Gasket:

Silicone, iron impregnated 220°C (428°F).

Lamp Holder:

GU5.3 - 350°C (662°F) ceramic multi contact lamp holder with 250°C (480°F) teflon cables.

Accessories:

Cable Joint Kit (Cat. CJK150).
Not approved for USA/Canada.

Frosted Lens (Cat. LENSAR111F).

Linear Spread Lens (Cat. LENS SPREAD).

Standards

IP66



UL1598

Luminaire Weight

4.8kgs (10lbs 8oz)

Power Supply

12 volt

HUNZA™ Inground or Wall Mount
Transformer: not included.

240 volt ac 50Hz.

HUNZA™ built in transformers.

USA and Canada:

12 volt

HUNZA™ Wall Mount
Transformer: not included.

120 volt ac 60 Hz.

HUNZA™ built in transformers.

Luminaire: supplied with

MR16 GU5.3 20, 35, 50 watt lamp max.

LED - Refer to previous page.

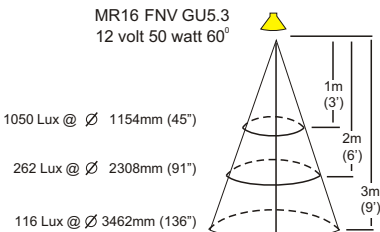
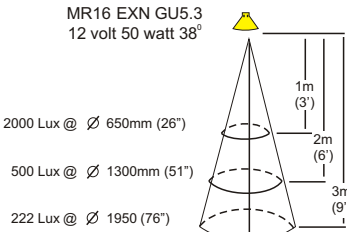
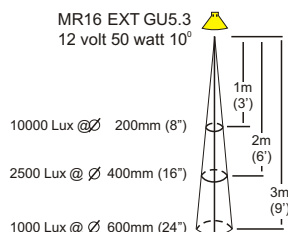
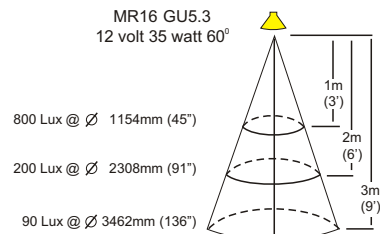
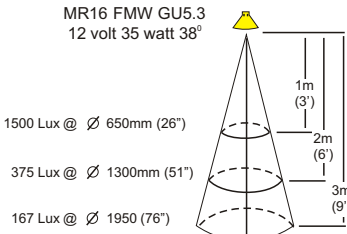
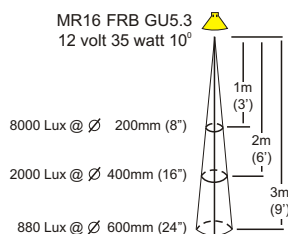
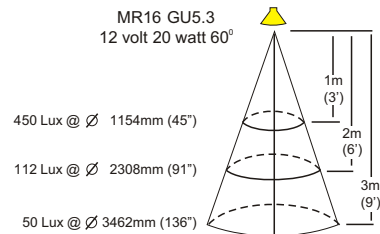
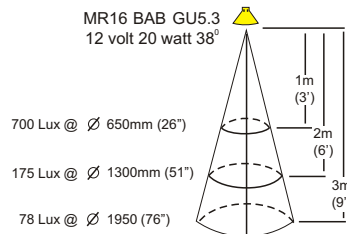
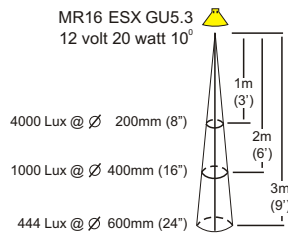

HUNZA™ PURE OUTDOOR LIGHTING

HUNZA FACTORY
130 Felton Mathew Ave
Glen Innes
Auckland 1072
New Zealand

Ph: 64-9-528 9471
Fax: 64-9-528 9361
hunza@hunza.co.nz
www.hunza.co.nz

INTERNATIONAL CONTACTS:
www.hunza.co.nz/contacts.php

Specifications may change without notice.
Manufactured in New Zealand.
© 2011 Hunza Holdings Ltd.

Ver 1.4