

## Lawn Lite Deck Mount PURE LED

PROJECT:
TYPE:
SOURCE:
NOTES:

### SPECIFICATIONS

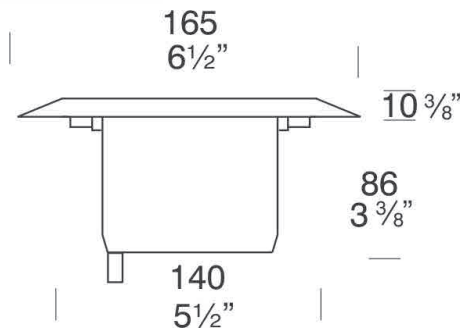

<b>LED Chip</b>	Cree XHP-50-2 Plug and Play field replaceable LED board
<b>Luminaire Output</b>	600 Lumens @ 1050mA (6 watts), 420 Lumens @ 700mA (4 watts), 240 Lumens @ 350mA (2 watts), delivered from luminaire with unobstructed beam.
<b>Lumens Per Watt</b>	100 Lumens @ 6 watts minimum, delivered from luminaire with unobstructed beam
<b>CRI (3000K)</b>	85+ Standard, 90+ Optional
<b>Colour Temperatures</b>	2700K, 3000K, 4000K
<b>Beam Angles</b>	15, 25, 38, 60
<b>Ingress Protection</b>	IP67
<b>Warranty</b>	Electronics = 5 years Flange SBZ/SS = 10 years Body Aluminium = 5 years
<b>Standards</b>	AS/NZS 61046 cUL 1838, 2108 CSA 22.2 No. 250.7, No. 250.0-08, CE

### PRODUCT CONFIGURATION

Please fill in appropriate codes into boxes provided

Cat. No. LLDMMV/L

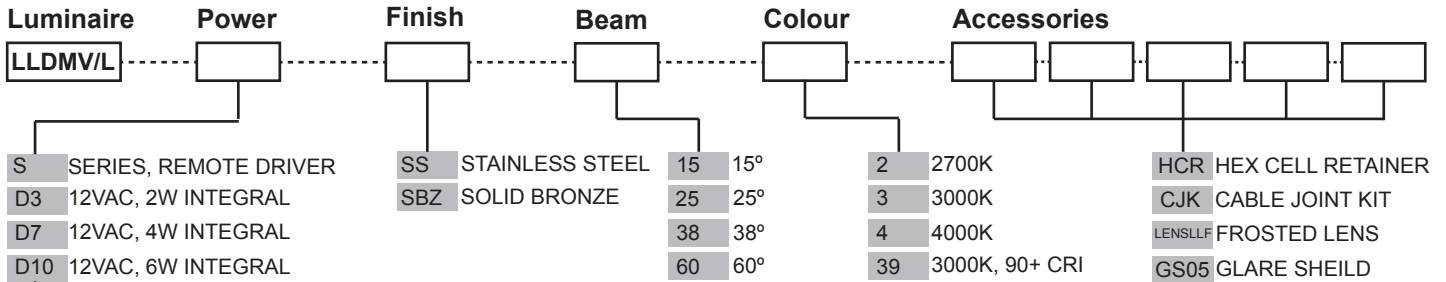

**SERIES, REMOTE DRIVER REQUIRED:**  
Constant current driver  
Individual fixtures require 6vdc @ 1050mA maximum

**12VAC INTEGRAL DRIVER:**  
Hunza integrated plug and play driver (included)  
Input: 9-15VAC.  
Output: 6vdc @ D3=350mA, D7=700mA, D10=1050mA (1050mA limited to ≤ 40°C (104°F) ambient temperature in stainless steel)

ADDITIONAL COMMENTS:

[Please click for Hunza Power Supply selection Chart](#)  
[Please click for Hunza Voltage drop Chart](#)

# LUMINAIRE CONSTRUCTION

**CNC machined from one of the following metals:**

**Aluminium:**

Body: cast from high corrosion resistant CC401 low copper aluminium alloy, with chromate substrate and high UV resistant polyester double powder coated.  
Colour: Black

**Solid Bronze:**

Flange: solid bronze bar 165mm (6½")

**316 Stainless Steel:**

Flange: 316 stainless steel 165mm (6½") rod.

**Flange:**

The flange is attached to the body by three 316 stainless steel allen head anti vandal screws.

**Lens:**

12mm (1/2") extra clear, low iron, flush fit, shatter resistant glass.  
Lifetime warranty

**Gaskets:**

Silicone 220°C (428°F)

**Mounting:**

Deck Mount version for mounting through a 145mm (5½") hole in a wooden or concrete deck.

Lawn Lite Deck Mount version is not suitable for driving over.

**Luminaire Weight:**

Low voltage

SBZ: 1.220kg (2lb 11oz)

SS: 1.510kg (3lb 5oz)

## ACCESSORIES

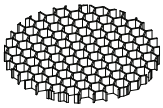

Hex Cell Retainer

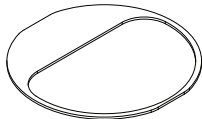

Glare Shield

## BEAM ANGLES

High efficiency PMMA TIR lenses. Field replaceable

IES files available for download: <http://www.hunzalighting.com/download.php>

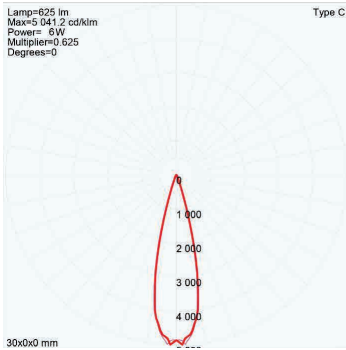

15° FWHM TIR

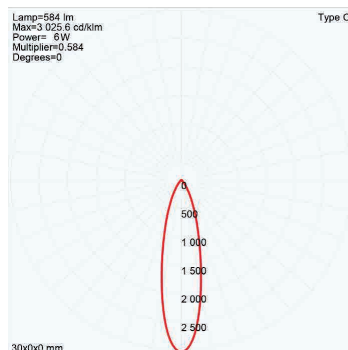

25° FWHM TIR

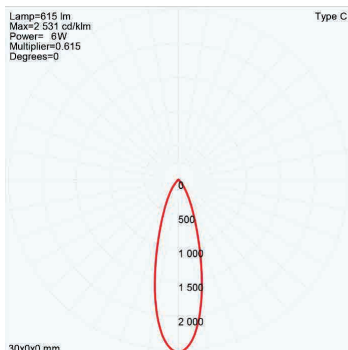

38° FWHM TIR

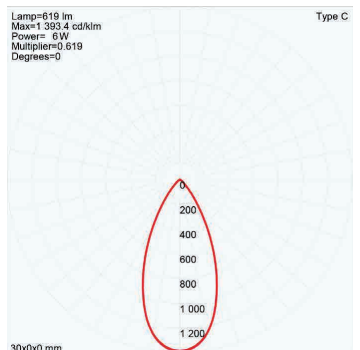

60° FWHM TIR

## WIRING GUIDE

Series/remote driver

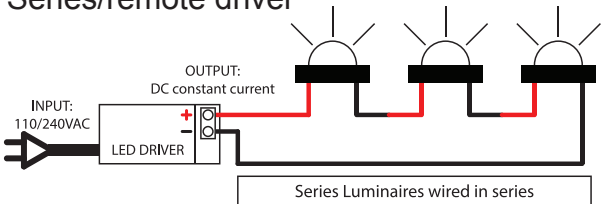

Diagrams are a guide only, wire colours and polarity may change depending on fixture and country

available for download: <http://www.hunzalighting.com/download.php>

12v integral driver

