

Pole Spot

Cat. No. PS

Cat. No. PSGU

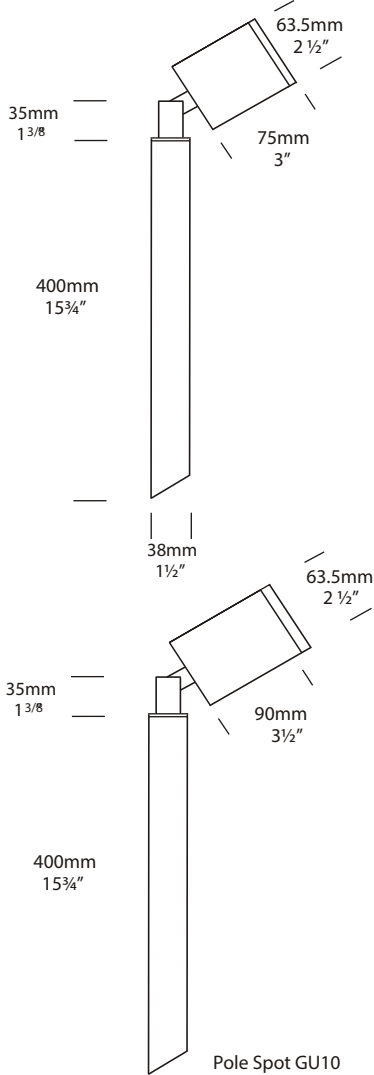

The Pole Spot has a single spotlight which has been designed for uplighting and cross lighting. This luminaire is best suited to illuminate larger bushes and shrubs, as well as architectural features. The fitting has a fully adjustable head which allows for 360 degree rotation, as well as a high degree of elevation.

This luminaire is machined from a choice of 10mm solid aluminium with a UV stable powder coated finish, solid copper or 316 stainless steel with a clear, tempered, flush glass lens and high temperature silicon gaskets. The Pole Spot uses a MR16 GU5.3 lamp.

A GU10 version of this luminaire is also available for line voltage lamps. However, a longer body is needed to accommodate the longer lamp.

Ordering Information

Luminaire Type

PS - Pole Spot

Material/Finish

BK - Black
 BZ - Bronze
 GN - Green
 STAR - Silver Star
 WH - White
 WB - Birch
 DG - Dark Grey
 OG - Olive Green
 RG - Beige
 PR - Primrose
 COP - Copper
 SS - 316 Stainless Steel

Accessories

CJK150 - Cable Joint Kit
 LENSSTEPF - Frost Lens
 GG - Glare Guard
 HCL - Hex Cell Louvre Adapter
 GU - GU10 Option

For LED options, refer to page 10.4 (dedicated LED), 10.4.3 (6 watt), 10.4.4 (3 watt) or <http://hunza.co.nz/l.html>

Ordering Example: PS COP - Pole Spot in Copper
 PSGU COP - Pole Spot GU10 in Copper
 GG COP - Glare Guard in Copper
 (Accessories ordered separately)

HUNZA™ PURE OUTDOOR LIGHTING

HUNZA FACTORY
 130 Felton Mathew Ave
 Glen Innes
 Auckland 1072
 New Zealand

Ph: 64-9-528 9471
 Fax: 64-9-528 9361
hunza@hunza.co.nz
www.hunza.co.nz

INTERNATIONAL CONTACTS:
www.hunza.co.nz/contacts.php

Specifications may change without notice.
 Manufactured in New Zealand.
 © 2011 Hunza Holdings Ltd.

Ver 1.4

Luminaire Construction

CNC machined from one of the following metals:

High corrosion resistant 63.5mm (2½") x 10mm (25/64") aluminium. End cap - solid aluminium 63.5mm (2½") rod, with chromate substrate and high UV resistant polyester powder coat - Colours Black, Bronze, Green, Silver Star.

Copper 63.5mm (2½") x 10mm (13/32"). End cap - solid Copper 63.5mm (2½") rod.

316 Stainless Steel 63.5mm x 9mm. End cap - solid 316 Stainless Steel 63.5mm (2½") rod.

Poles Aluminium, Copper, 316 Stainless Steel 38mm (1½") x 400mm (15¾").

Mounting

The pole 400mm (15¾") is directly mounted into the earth or concrete.

Features

Lens:
10mm (3/8") clear 'flush fit' shatter resistant glass. Lifetime Warranty.

Gaskets:
Silicone, iron impregnated 220°C (428°F).

Lamp Holder:
GU5.3 & GU10 - 350°C (662°F) ceramic multi contact lamp holder with 250°C (480°F) teflon cables.

Accessories:
Cable Joint Kit (Cat. CJK150).
Frosted Lens (Cat. LENSSTEPF).
Glare Guard (Cat. GG).
Hex Cell Louvre Adapter (Cat. HCL).
GU10 Option (Cat. GU).

Swivel:
Aluminium and Copper Luminaires 360° rotation and a high degree of elevation, solid brass with anti rust spring.

Stainless Steel luminaires 360 degree rotation and a high degree of elevation, full 316 stainless steel construction.

Standards

IP66



Luminaire Weight

Alum 1.00kg (2lb 3oz)
Cop 1.70kg (3lb 12oz)
SS 1.50kg (3lb 5oz)

Power Supply

HUNZA™ Inground or Wall Mount Transformer: Not included

Luminaire: Supplied With

MR16 GU5.3 20 or 35 watt lamp max.
GU10 - GU10 25 or 35 watt lamp max.
LED - Refer to previous page.

USA and Canada:

MR16 GU5.3 20 or 35 watt lamp max.
GU10 Halogen - Lamp not supplied
LED - Refer to previous page.

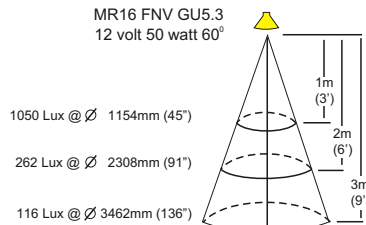
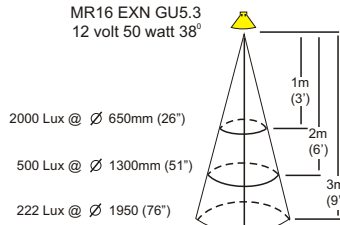
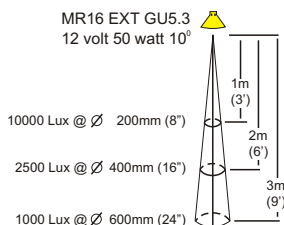
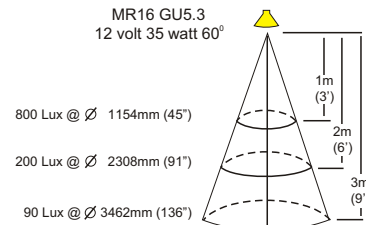
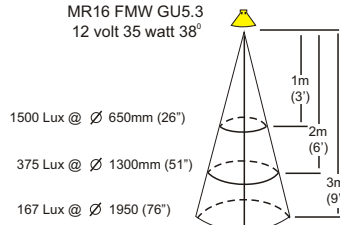
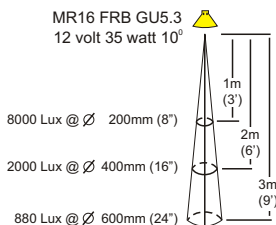
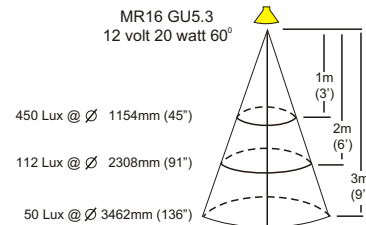
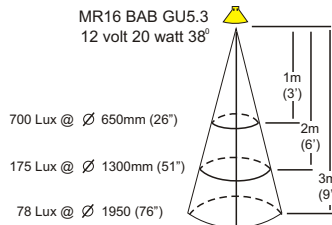
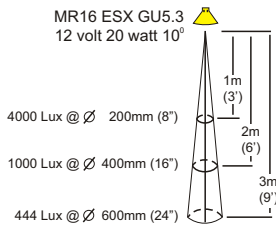

HUNZA™ PURE OUTDOOR LIGHTING

HUNZA FACTORY
130 Felton Mathew Ave
Glen Innes
Auckland 1072
New Zealand

Ph: 64-9-528 9471
Fax: 64-9-528 9361
hunza@hunza.co.nz
www.hunza.co.nz

INTERNATIONAL CONTACTS:
www.hunza.co.nz/contacts.php

Specifications may change without notice.
Manufactured in New Zealand.
© 2011 Hunza Holdings Ltd.