

Pond Lite

Cat. No. POND

Cat. No. POND/W

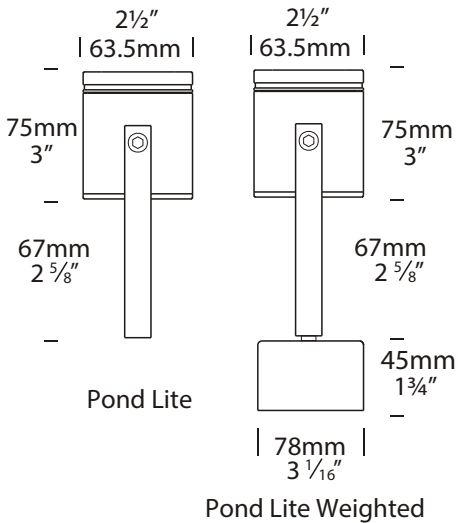

The Pond Lite is fully submersible and is adjustable on two planes. The luminaire is ideal for illuminating sculptures or other water features. A version with a weighted base is available, allowing the luminaire to be placed in the pond without drilling fixing holes to mount it. It is supplied with a 3 metre (9ft 10 7/64") submersible cable.

This luminaire is machined from a choice of 10mm solid aluminium with a UV stable powder coated finish, solid copper or 316 stainless steel with a clear, tempered, flush glass lens and high temperature silicon gaskets.

CAUTION! Do not use the copper fixtures in fish pond!

Ordering Information

Luminaire Type

POND - Pond Lite

Material/Finish

BK - Black
 BZ - Bronze
 GN - Green
 STAR - Silver Star
 WH - White
 WB - Birch
 DG - Dark Grey
 OG - Olive Green
 RG - Beige
 PR - Primrose
 COP - Copper
 SS - 316 Stainless Steel

Accessories

CJK150 - Cable Joint Kit
 LENSSTEPF - Frosted Lens
 GG - Glare Guard
 HCL - Hex Cell Louvre Adaptor
 /W - Weighted Base



Ordering Example: POND/W SS - Pond Lite Weighted Version in 316 Stainless Steel.

HCL SS - Hex Cell Louvre Adaptor in 316 Stainless Steel
 (Accessories ordered separately)

HUNZA™ PURE OUTDOOR LIGHTING

HUNZA FACTORY
 130 Felton Mathew Ave
 Glen Innes
 Auckland 1072
 New Zealand

Ph: 64-9-528 9471
 Fax: 64-9-528 9361
 hunza@hunza.co.nz
 www.hunzalighting.com

INTERNATIONAL CONTACTS:
<http://www.hunzalighting.com/contact.php>

Specifications may change without notice.
 Manufactured in New Zealand.
 © 2016 Hunza Holdings Ltd. Ver 1.4

Luminaire Construction

CNC machined from one of the following metals:

High corrosion resistant 63.5mm (2½") x 10mm (25/64") aluminium.
End cap - solid aluminium 63.5mm (2½") rod, with chromate substrate and high UV resistant polyester powder coat

Colours Black, Bronze, Green, Silver Star, White, Birch, Dark Green, Olive Green, Beige, Primrose.

USA/Canada

Aluminium is not approved.

Copper 63.5mm (2½") x 10.5mm (13/32"). End cap - solid copper 63.5mm (2½") rod.

316 Stainless Steel 63.5mm (2½") x 9mm (11/32"). End cap - solid 316 stainless steel 63.5mm (2½") rod.

Mounting

Via a "U" bracket that is screwed to the mounting surface. If being used in a pond with a plastic liner then the weighted version should be used. No screws are required for fixing, therefore no leaks.

Note: Copper may not be suitable for use with fish. May be mounted to a depth of 2 metres.

Features

Lens:

10mm (3/8") thick clear 'flush fit' tempered shatter resistant glass.

Lifetime Warranty.

Gaskets:

Silicone, iron impregnated 220°C (428°F).

Lamp Holder:

GU5.3 - 350°C (662°F) ceramic multi contact lamp holder with 250°C (480°F) teflon cables.

Cable:

1.3mm (16AWG) 3 metre (9") submersible cable, longer cable available on Request.

Accessories:

Cable Joint Kit (Cat. CJK150)

Not approved for USA /Canada.

Frosted Lens (Cat. LENSSTEPF).

Glare Guard (Cat. GG).

Hex Cell Louvre Adaptor (Cat. HCL).

Weighted Base (Cat. /W).

Standards

EN60598

IP68



UL676

Luminaire Weight (including cable)

Alum .740kg (1lb 11oz)

Cop 1.50kg (3lb 4oz)

SS 1.30kg (2lb 13oz)

Weighted Version

Alum 1.165 (2lb 9oz)

Cop 2.050 (4lb 6oz)

SS 1.880 (4lb 2oz)

Power Supply

HUNZA™ Inground or Wall Mount Transformer: not included.

USA and Canada:

Ground shielded earth transformer: not included.

Luminaire: supplied with MR16 GU5.3 20 or 35 watt lamp max.

USA and Canada:
MR16 GU5.3 20 or 35 watt lamp max.

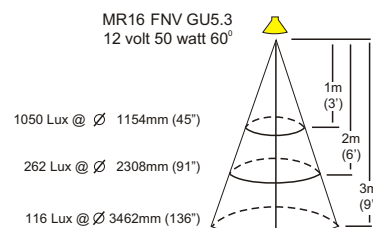
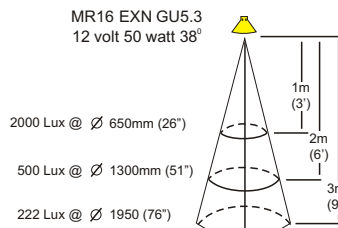
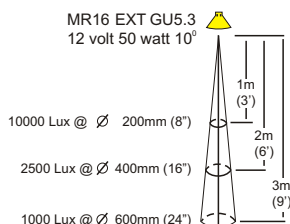
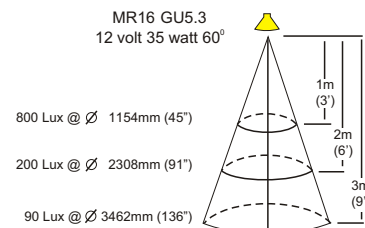
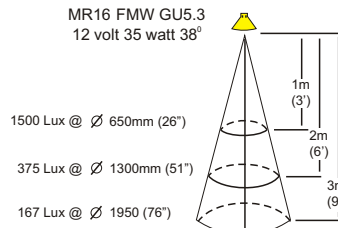
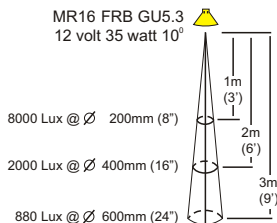
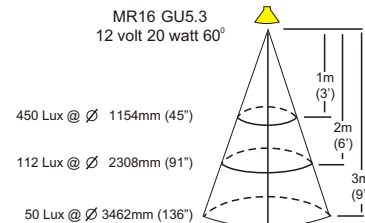
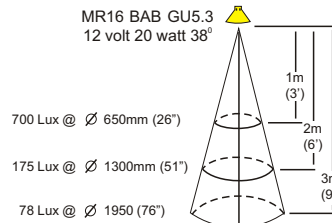
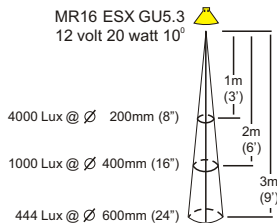

HUNZA™ PURE OUTDOOR LIGHTING

HUNZA FACTORY
130 Felton Mathew Ave
Glen Innes
Auckland 1072
New Zealand

Ph: 64-9-528 9471
Fax: 64-9-528 9361
hunza@hunza.co.nz
www.hunzalighting.com

INTERNATIONAL CONTACTS:
<http://www.hunzalighting.com/contact.php>

Specifications may change without notice.
Manufactured in New Zealand. Ver 1.4
© 2016 Hunza Holdings Ltd.