

Spike Spot High Power / Retro PURE LED

PROJECT: _____

TYPE: _____

SOURCE: _____

NOTES: _____

SPECIFICATIONS

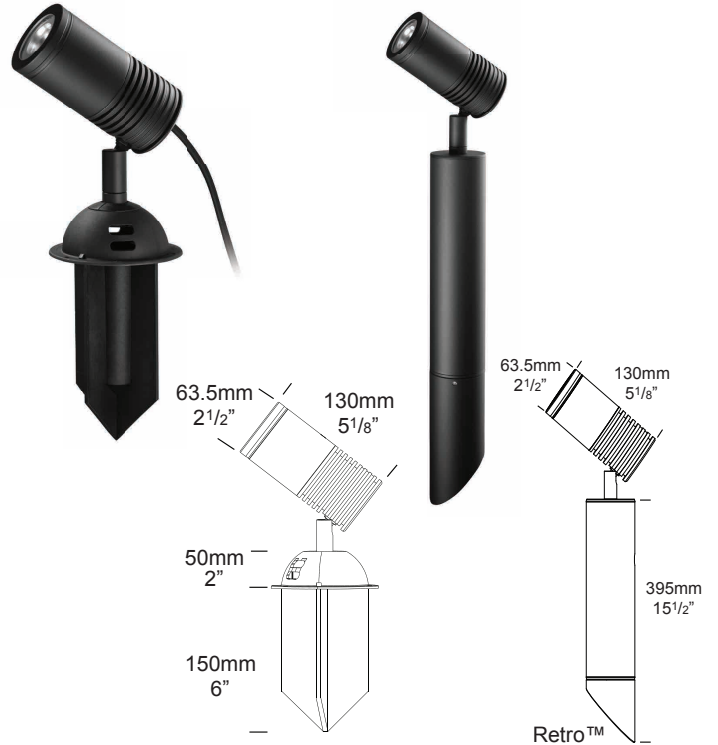

LED Chip	Cree XHP-50-2 Plug and Play field replaceable LED board
Luminaire Output	1000 Lumens @ 2000mA delivered from luminaire with unobstructed beam.
Lumens Per Watt	83 Lumens minimum @ 12 watts, delivered from luminaire with unobstructed beam
CRI (3000K)	85+ Standard, 90+ Optional
Colour Temperatures	2700K, 3000K, 4000K
Beam Angles	15, 25, 38, 60
Ingress Protection	IP66

Warranty	Electronics = 5 years Body Aluminium = 5 years
Standards	AS/NZS 61046 cUL 2108, 1598 CSA C22.2 No. 250.0-08, No. 250.0 CE

PRODUCT CONFIGURATION

Please fill in appropriate codes into boxes provided

Cat. No. SS/HP/S/L or SS/HP/R/L

Luminaire	Power	Material/ Finish	Beam	Colour	Accessories
<input type="text" value="SS/HP/S/L"/> <input type="text" value="SS/HP/R/L"/>	<input type="text"/>	<input type="text"/>	<input type="text"/>	<input type="text"/>	<input type="text"/>
S SERIES, REMOTE DRIVER R RETRO, 110/240V DRIVER		ALUMINIUM EBK BLACK EBZ BRONZE EOGR OLIVE GREEN EWH WHITE EWB WHITE BIRCH EDG DARK GREY ESTAR SILVER STAR ECT CORTEN	15 15° 25 25° 38 38° 60 60°	2 2700K 3 3000K 4 4000K 39 3000K, 90+ CRI	LKN LOCKING KNUCKLE HCL HEX CELL LOUVRE SNT SNOOT GG GLARE GUARD LF FROSTED LENS CJK CABLE JOINT KIT FM FLANGE MOUNT (Retro version only) FM90 EXTERNAL 90MM FLANGE MOUNT (Retro version only)

SERIES, REMOTE DRIVER REQUIRED:
Constant current driver
Individual fixtures require 6vdc @ 2000mA maximum

110/240VAC RETRO DRIVER:
Input: 90/305vac (included)
Output: 6vdc, 2000mA
0-10 volt dimming
(USA - non dimming)

ADDITIONAL COMMENTS: _____

[Please click for Hunza Power Supply selection Chart](#)
[Please click for Hunza Voltage drop Chart](#)

LUMINAIRE CONSTRUCTION

CNC machined from one of the following metals:

Aluminium:

Body: high corrosion resistant 63.5mm (2^{1/2}") x 10mm (3/8") aluminium.

Driver Housing (Retro™): solid aluminium 63.5mm (2^{1/2}") x 3.25mm (1/8") tube with chromate substrate and high UV resistant polyester "E" powder coat.

Colours:

Black, Bronze, Silver Star, White, White Birch, Olive Green, Dark Grey, Corten.

Knuckles:

Aluminium luminaires: 360° rotation and 0-90° elevation, solid brass with anti rust spring.

Cable:

Water resistant rubber with HUNZA™ Anti-Syphon™ barrier system.

Lens:

10mm (3/8") Extra clear, low iron, shatter resistant glass.

Lifetime warranty

Gaskets:

Silicone, iron impregnated 220°C (428°F)

Mounting:

Series: Ground spike 150mm (6") or 300mm (12") inserted directly into the earth.

Retro™ (110/240-12volt): driver housing pole 395mm (15^{1/2}") is directly mounted into the earth.

Flange Mount option is available for hard surfaces.

Luminaire Weight:

Low voltage:

Alum: 0.870 (1lb 15oz)

Retro™

Alum: 1.500 (3lb 5oz)

ACCESSORIES

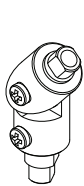

Locking Knuckle

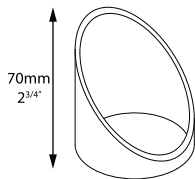

Glare Guard

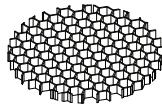

Hex Cell Louvre

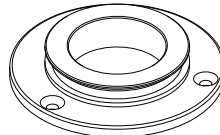

External Flange Mount

BEAM ANGLES

High efficiency PMMA TIR lenses. Field replaceable

IES files available for download: <http://www.hunzalighting.com/download.php>

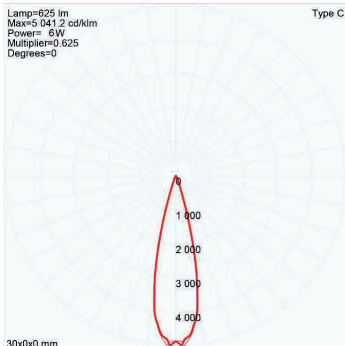

15° FWHM TIR

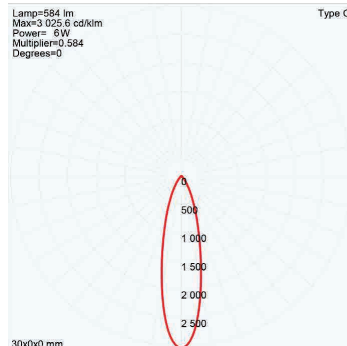

25° FWHM TIR

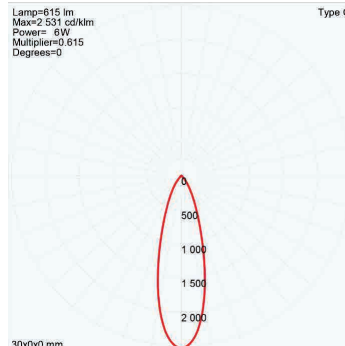

38° FWHM TIR

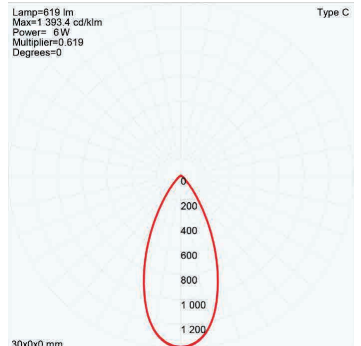

60° FWHM TIR

WIRING GUIDE

Series/remote driver

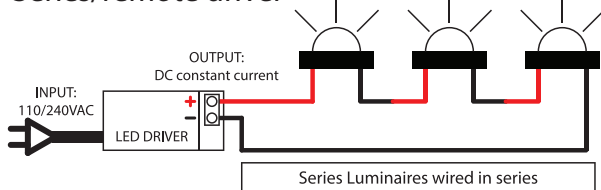

Series Luminaires wired in series

available for download: <http://www.hunzalighting.com/download.php>

12v integral driver

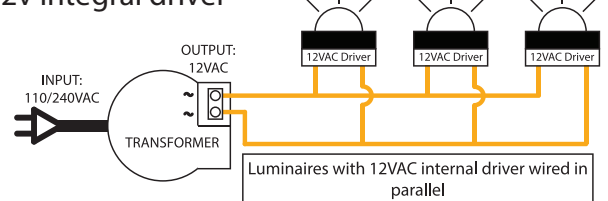

Luminaires with 12VAC internal driver wired in parallel

Diagrams are a guide only, wire colours and polarity may change depending on fixture and country

Specifications may change without notification

Aug 2017