

Step Lite Solid Eyelid

PROJECT:

TYPE:

SOURCE:

NOTES:

PURELED SPECIFICATIONS

LED Chip	Cree XHP-50-2 Plug and Play field replaceable LED board
Luminaire Output	600 Lumens @ 1050mA (6 watts), 420 Lumens @ 700mA (4 watts), 240 Lumens @ 350mA (2 watts), delivered from luminaire with unobstructed beam.
Lumens Per Watt	100 Lumens @ 6 watts minimum, delivered from luminaire with unobstructed beam
CRI (3000K)	85+ Standard, 90+ Optional
Colour Temperatures	2700K, 3000K, 4000K
Beam Angles	15, 25, 38, 60
Ingress Protection	IP67
Warranty	Electronics = 5 years Body Cop/SS = 10 years Body Aluminium = 5 years
Standards	AS/NZS 61046 cUL 1838, 2108 CSA C22.2 No.250.7, No.250.0-08 CE

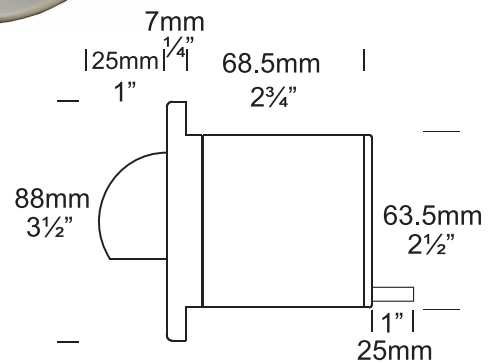

PRODUCT CONFIGURATION

Please fill in appropriate codes into boxes provided

Cat. No. SLS/L

Luminaire	Power	Material/ Finish	Beam	Colour	Accessories
<input type="text" value="SLS/L"/>	<input type="text"/>	<input type="text"/>	<input type="text"/>	<input type="text"/>	<input type="text"/>
S SERIES, REMOTE DRIVER D3 12VAC, 2W INTEGRAL D7 12VAC, 4W INTEGRAL D10 12VAC, 6W INTEGRAL		ALUMINIUM EBK BLACK EBZ BRONZE EOGR OLIVE GREEN EWH WHITE EWB WHITE BIRCH EDG DARK GREY ESTAR SILVER STAR ECT CORTEN COP SOLID COPPER SS STAINLESS STEEL	15 15° 25 25° 38 38° 60 60°	2 2700K 3 3000K 4 4000K 39 3000K, 90+ CRI	HCL HEX CELL LOUVRE LF FROSTED LENS CJK CABLE JOINT KIT DKCAN DECK CANISTER SLCAN STEP LITE CANISTER CANSS STAINLESS STEEL CANISTER TLTM TILTING MODULE

SERIES, REMOTE DRIVER REQUIRED:
Constant current driver
Individual fixtures require 6vdc @ 1050mA maximum

12VAC INTEGRAL DRIVER:
Hunza integrated plug and play driver (included)
Input: 9-15VAC.
Output: 6vdc @ D3=350mA, D7=700mA, D10=1050mA (1050mA limited to ≤ 40°C (104°F) ambient temperature in stainless steel)

OTHER LAMP OPTIONS:
 SLS/H - MR16 Halogen 12V Lamp
 SLS/SL - MR16 LED Retrofit 12V Lamp (lamps vary by market - please refer to supplier for details)
 SLS/GUH - GU10 120/240V Halogen Lamp (body length increases for all GU10 lamps)
 SLS/GUSL - GU10 LED Retrofit 120/240V Lamp (lamps vary by market - please refer to supplier for details)

[Click here for halogen specification sheet](#)

Please click for Remote Power Supply Guidance Charts:

[USA \(page 1\)](#)

[Rest of the World \(page 1\)](#)

LUMINAIRE CONSTRUCTION

CNC machined from one of the following metals:

Aluminium:

Body: high corrosion resistant 63.5mm (2^{1/2"}) x 10mm (3/8") aluminium.

Flange: 90mm (3^{1/2"}) solid aluminium rod.

End cap: solid aluminium 63.5mm (2^{1/2"}) rod with chromate substrate and high UV resistant polyester powder coat.

Colours:

Black, Bronze, Silver Star, White, White Birch, Olive Green, Dark Grey, Corten.

Copper:

Body: 63.5mm (2^{1/2"}) x 10mm (3/8").

Flange: 90mm (3^{1/2"}) solid copper rod.

End cap: solid copper 63.5mm (2^{1/2"}) rod.

316 Stainless Steel:

Body: 63.5mm (2^{1/2"}) x 10mm (3/8").

Flange: 90mm (3^{1/2"}) 316 stainless steel rod.

End cap: 316 stainless steel 63.5mm (2^{1/2"}) rod.

Step Lens:

10mm (3/8") extra clear, low iron, flush fit, shatter resistant glass.

Lifetime warranty

Gaskets:

Silicone, iron impregnated 220°C (428°F)

Mounting:

Designed to fit through a 66mm (2^{5/8"}) hole and be fixed into position by two screws in the flange or a Step Lite Canister (see accessories) can be used which maintains the aesthetic look of the flange by eliminating the two screw holes in the flange.

Luminaire Weight:

Low voltage

Alum: 0.465kg (1lb)

Cop: 1.340kg (2lb 15oz)

SS: 1.055 (2lb 5oz)

ACCESSORIES

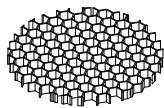

Hex Cell Louvre

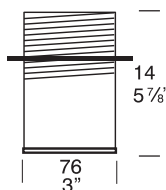

Deck Canister

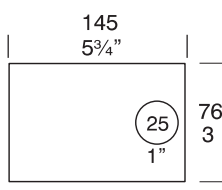

Step Lite & Stainless Steel Canister

BEAM ANGLES

High efficiency PMMA TIR lenses. Field replaceable

IES files available for download: <http://www.hunzalighting.com/download.php>

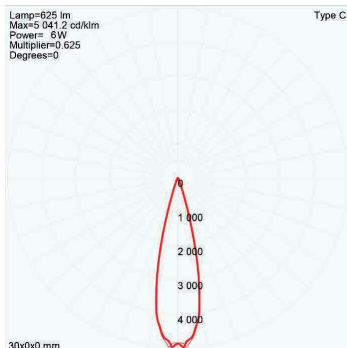

15° FWHM TIR

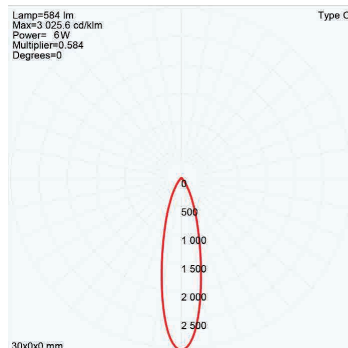

25° FWHM TIR

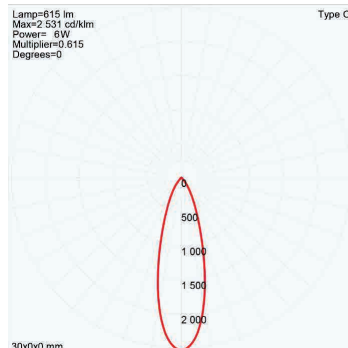

38° FWHM TIR

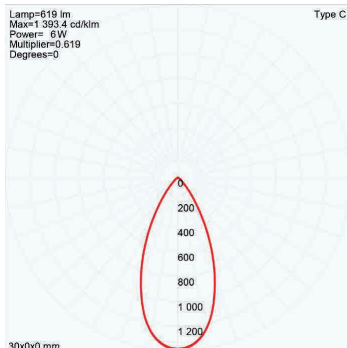

60° FWHM TIR

WIRING GUIDE

Series/remote driver

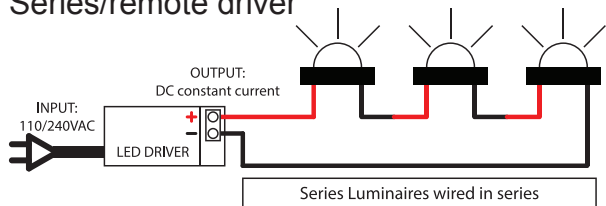

Series Luminaires wired in series

available for download: <http://www.hunzalighting.com/download.php>

12v integral driver

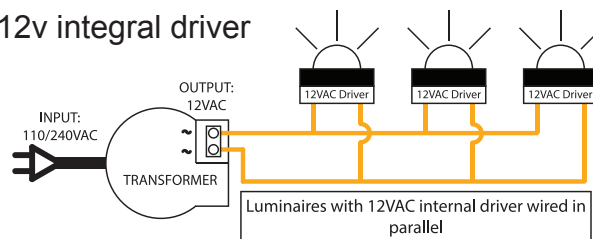

Luminaires with 12VAC internal driver wired in parallel

Diagrams are a guide only, wire colours and polarity may change depending on fixture and country

Specifications may change without notification

Aug 2017