

PROJECT:
TYPE:
SOURCE:
NOTES:

Step Lite Square PURE LED

SPECIFICATIONS



LED Chip	Cree XHP-50-2 Plug and Play field replaceable LED board
Luminaire Output	600 Lumens @ 1050mA (6 watts), 420 Lumens @ 700mA (4 watts), 240 Lumens @ 350mA (2 watts), delivered from luminaire with unobstructed beam.
Lumens Per Watt	100 Lumens @ 6 watts minimum, delivered from luminaire with unobstructed beam
CRI (3000K)	85+ Standard, 90+ Optional
Colour Temperatures	2700K, 3000K, 4000K
Beam Angles	15, 25, 38, 60
Ingress Protection	IP67
Warranty	Electronics = 5 years Body Cop/SS = 10 years Body Aluminium = 5 years
Standards	AS/NZS 61046 cUL 1838, 2108 CSA C22.2 No.250.7, No.250.0-08 CE

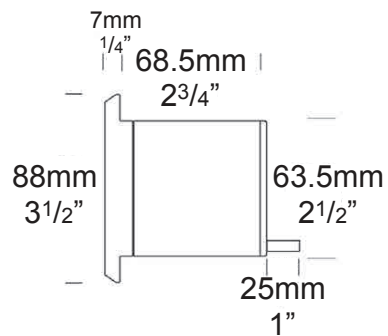

PRODUCT CONFIGURATION

Please fill in appropriate codes into boxes provided

Cat. No. SLSQ/L

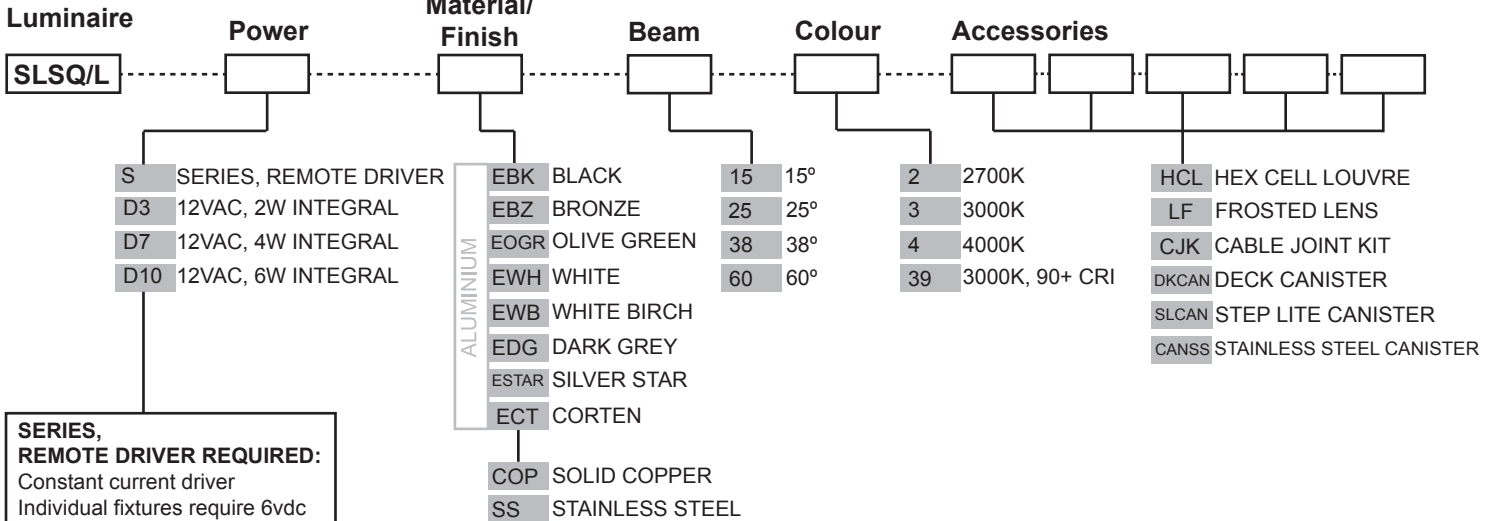

SERIES, REMOTE DRIVER REQUIRED:
Constant current driver
Individual fixtures require 6vdc @ 1050mA maximum

12VAC INTEGRAL DRIVER:
Hunza integrated plug and play driver (included)
Input: 9-15VAC.
Output: 6vdc @ D3=350mA, D7=700mA, D10=1050mA (1050mA limited to ≤ 40°C (104°F) ambient temperature in stainless steel)

ADDITIONAL COMMENTS:

[Please click for Hunza Power Supply selection Chart](#)
[Please click for Hunza Voltage drop Chart](#)

LUMINAIRE CONSTRUCTION

CNC machined from one of the following metals:

Aluminium:

Body: high corrosion resistant 63.5mm (2^{1/2}" x 10mm (3/8") aluminium.

Flange: 90mm x 90mm (3^{1/2}" x 3^{1/2}") solid aluminium rod.

End cap: solid aluminium 63.5mm (2^{1/2}" rod with chromate substrate and high UV resistant polyester powder coat.

Colours:

Black, Bronze, Silver Star, White, White Birch, Olive Green, Dark Grey, Corten.

Copper:

Body: 63.5mm (2^{1/2}" x 10mm (3/8").

Flange: 90mm x 90mm (3^{1/2}" x 3^{1/2}") solid copper rod.

End cap: solid copper 63.5mm (2^{1/2}" rod.

316 Stainless Steel:

Body: 63.5mm (2^{1/2}" x 10mm (3/8").

Flange: 90mm x 90mm (3^{1/2}" x 3^{1/2}") solid 316 stainless steel.

End cap: solid 316 stainless steel 63.5 (2^{1/2}" rod.

Step Lens:

10mm (3/8") extra clear, low iron, flush fit, shatter resistant glass.

Lifetime warranty

Gaskets:

Silicone, iron impregnated 220°C (428°F)

Mounting:

Designed to fit through a 66mm (2^{5/8}") hole and be fixed into position by two screws in the flange or a Step Lite Canister (see accessories) can be used which maintains the aesthetic look of the flange by eliminating the two screw holes in the flange.

Luminaire Weight:

Low voltage

Alum: 0.465kg (1lb)

Cop: 1.340kg (2lb 15oz)

SS: 1.055kg (2lb 5oz)

ACCESSORIES

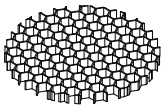

Hex Cell Louvre

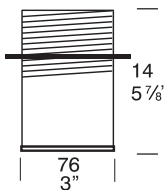

Deck Canister

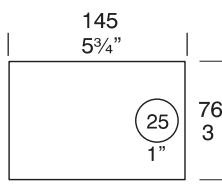

Step Lite & Stainless Steel Canister

BEAM ANGLES

High efficiency PMMA TIR lenses. Field replaceable

IES files available for download: <http://www.hunzalighting.com/download.php>

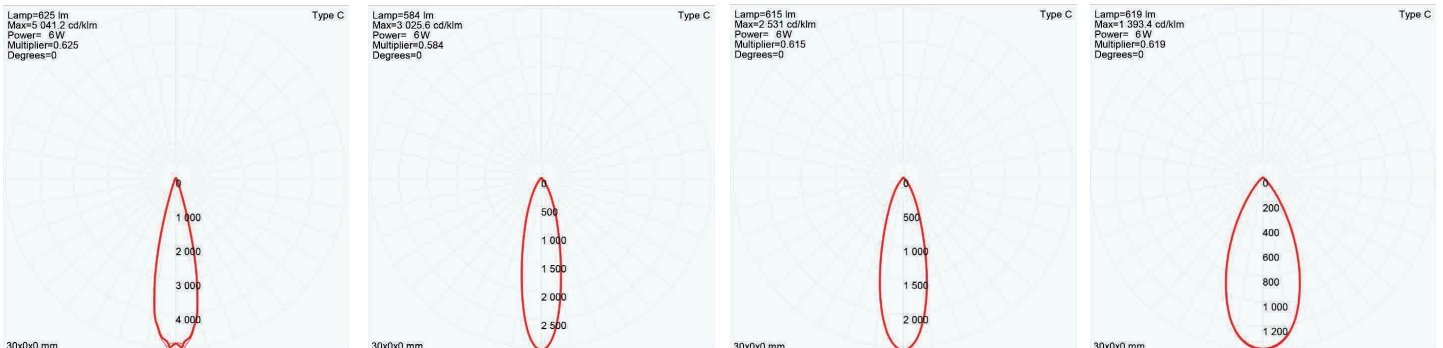

15° FWHM TIR

25° FWHM TIR

38° FWHM TIR

60° FWHM TIR

WIRING GUIDE

Series/remote driver

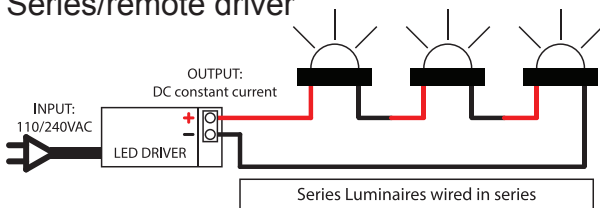

available for download: <http://www.hunzalighting.com/download.php>

12v integral driver

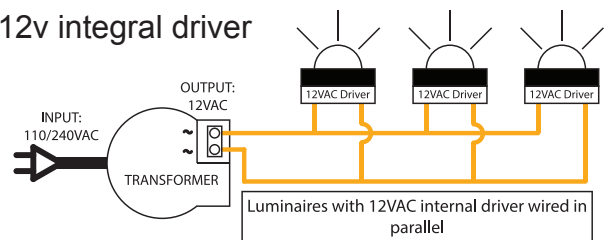

Diagrams are a guide only, wire colours and polarity may change depending on fixture and country

Specifications may change without notification

Aug 2017

HUNZA™ PURE OUTDOOR LIGHTING

HUNZA FACTORY 130 Felton Mathew Ave
Saint Johns
Auckland 1072
New Zealand

Ph: +64-9-528 9471
Fax: +64-9-528 9361
hunza@hunza.co.nz
www.hunzalighting.com

INTERNATIONAL CONTACTS:
<http://www.hunzalighting.com/contact.php>

This document contains proprietary information of Hunza. Its receipt or possession does not convey any rights to reproduce or disclose its content.