

# Sign Lite

Cat. No. SGNL

Cat. No. SGNLGU

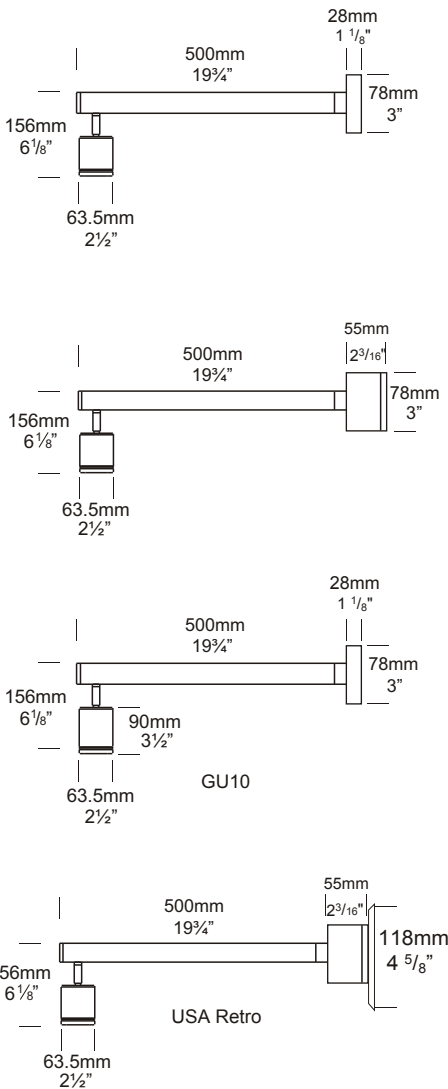
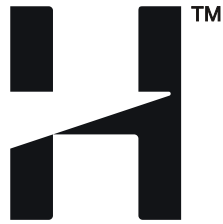

The Sign Lite is for lighting signs, wall displays, building highlights, and external barbeques. The fully adjustable head is mounted on the end of a 500mm (19.5") arm, allowing 360 degree rotation and 90 degree elevation.

Available in 12 volt or with a built in 110 or 240 volt transformer (Retro™) option. This luminaire is machined from a choice of 10mm solid aluminium with a UV stable powder coated finish, solid copper or 316 stainless steel with a clear, tempered, flush glass lens and high temperature silicon gaskets.

A GU10 version of this luminaire is also available for line voltage lamps. However, a longer luminaire body is needed to accommodate the longer lamp.

## Ordering Information

### Luminaire Type

SGNL- Sign Lite

### Material/Finish

- BK - Black
- BZ - Bronze
- GN - Green
- STAR - Silver Star
- WH - White
- WB - Birch
- DG - Dark Grey
- OG - Olive Green
- RG - Beige
- PR - Primrose
- COP - Copper
- SS - 316 Stainless Steel

### Accessories

- CJK150 - Cable Joint Kit
- LENSSTEPF - Frost Lens
- GG - Glare Guard
- HCL - Hex Cell Louvre Adaptor
- /R - Retro™ Transformer  
110/240-12 volt
- GU - GU10 Option

Ordering Example: SGNL SS - Sign Lite 316 Stainless Steel

SGNLGU COP - Sign Lite GU10 in Copper

HCL - Hex Cell Louvre Adaptor

(Accessories ordered separately)



**HUNZA**™ PURE  
OUTDOOR  
LIGHTING

**HUNZA FACTORY**  
130 Felton Mathew Ave  
Glen Innes  
Auckland 1072  
New Zealand

Ph: 64-9-528 9471  
Fax: 64-9-528 9361  
hunza@hunza.co.nz  
www.hunza.co.nz

**INTERNATIONAL CONTACTS:**  
www.hunza.co.nz/contacts.php

Specifications may change without notice.  
Manufactured in New Zealand.  
© 2011 Hunza Holdings Ltd.

Ver 1.4

## Luminaire Construction

CNC machined from one of the following metals:

High corrosion resistant 63.5mm (2½") x 10mm (25/64") aluminium. End cap - solid aluminium 63.5mm (2½") rod, with chromate substrate and high UV resistant polyester powder coat - Colours Black, Bronze, Green, Silver Star, White, Birch, Dark Green, Olive Green, Beige, Primrose.

**Copper** 63.5mm (2½") x 10mm (13/32"). End cap - solid copper 63.5mm (2½") rod.

**316 Stainless Steel** 63.5mm (2½") x 9mm (11/32"). End cap - solid 316 stainless steel 63.5mm (2½") rod.

**Poles** Aluminium, Copper, 316 Stainless 38mm (1½") x 500mm (19¾") tube.

## Mounting

12 volt: the luminaire is mounted to the wall using two 316 stainless screws through a shallow base 16mm (5/8") in depth. A Wall Box Adaptor Plate is available as an accessory to fit 3.0 and 4.0 junction boxes for USA/Canada.

Retro™ 110/240-12 volt: a mounting plate is fixed to the wall using two screws, the luminaire is fitted to the mounting plate.

## Features

**Lens:**  
10mm (3/8") clear flush fit shatter resistant glass. Lifetime Warranty.

**Gaskets:**  
Silicone, iron impregnated 220°C (428°F).

**Lamp Holder:**  
GU5.3 & GU10 - 350°C (662°F)  
ceramic multi contact lamp holder with 250°C (480°F) teflon cables.

**Accessories:**  
Cable Joint Kit (Cat. CJK150).  
Not approved for USA /Canada.  
Frosted Lens (Cat. LENSSTEPF).  
Glare Guard (Cat. GG).  
Hex Cell Louvre Adaptor (Cat. HCL).  
Retro™ transformer 110/240-12 volt (Cat. /R) IP66.  
GU10 Option (Cat. GU).

**Swivel:**  
**Aluminium** and **Copper** luminaires 360° rotation and 0 - 90° elevation, solid brass with anti rust spring.

**Stainless Steel** luminaires 360° rotation and 0 - 90° elevation, full stainless steel construction.

## Standards

IP56/IP66  UL1838

**Luminaire Weight**  
12 volt: Alum 1kg (2lb 2oz)  
Cop 2.140kg (4lb 11oz)  
SS 1.620kg (3lb 9oz)  
Retro™: Alum 1.5kg (3lb 3oz)  
Cop 3.200kg (7lb)  
SS 3.055kg (6lb 11oz)

**Power Supply**  
HUNZA™ Inground or Wall Mount  
Transformer: not included.

HUNZA™ 110/240-12 volt ac potted electronic transformer is built into the base.  
Dimmable with a suitable dimmer.

USA and Canada:  
HUNZA™ Wall Mount Transformer: not included.

**Luminaire: supplied with**  
MR16 GU5.3 20, 35 watt lamp max.  
GU10 - GU10 25 or 35 watt lamp max.

USA and Canada:  
MR16 GU5.3 20, 35 watt lamp max.  
GU10 Halogen - Lamp not supplied

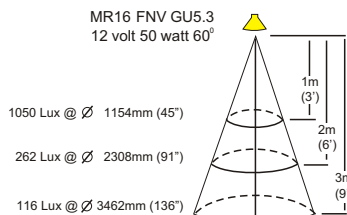
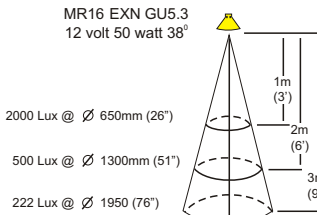
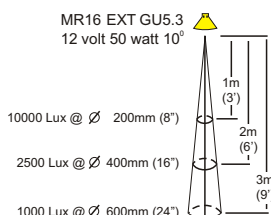
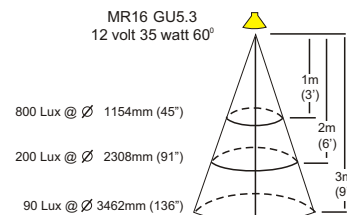
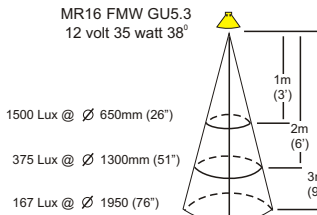
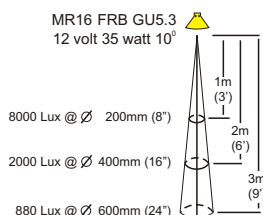
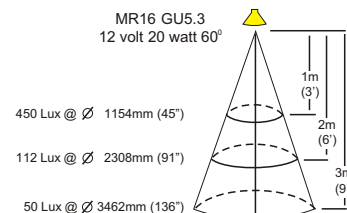
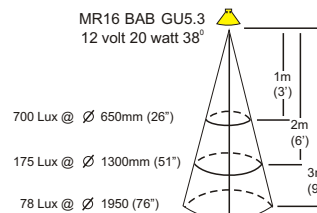
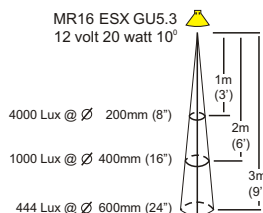

**HUNZA™** PURE OUTDOOR LIGHTING

**HUNZA FACTORY**  
130 Felton Mathew Ave  
Glen Innes  
Auckland 1072  
New Zealand

Ph: 64-9-528 9471  
Fax: 64-9-528 9361  
hunza@hunza.co.nz  
www.hunza.co.nz

**INTERNATIONAL CONTACTS:**  
www.hunza.co.nz/contacts.php

Specifications may change without notice.  
Manufactured in New Zealand.  
© 2011 Hunza Holdings Ltd.

Ver 1.4