

Single Pole Lite

Cat. No. SPL

Cat. No. SPL/R

Cat. No. SPLGU

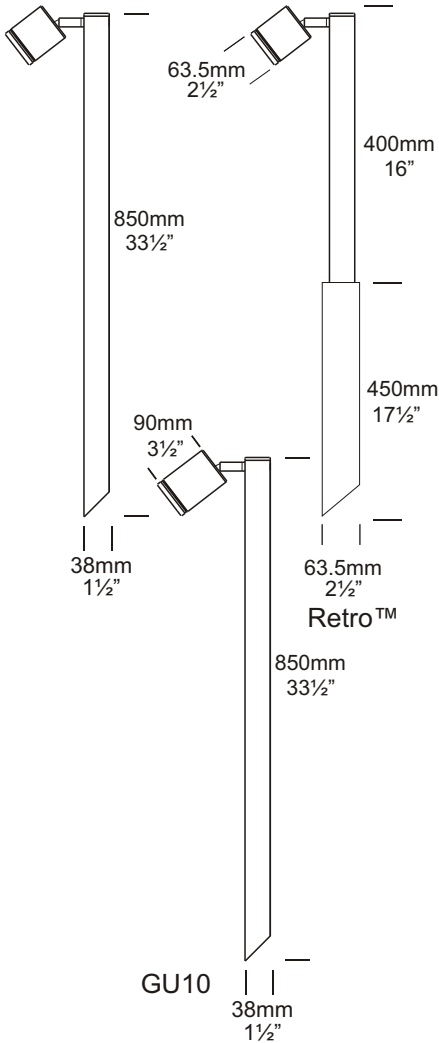

Single Pole Lite

The Single Pole Lite has an individual spotlight which can be aimed in any direction. The fixture is ideal for path lighting as well as tree lighting, or the head may be aimed downward to eliminate vertical light. The fitting has a fully adjustable arm allowing 360 degree rotation and 0 - 90 degree elevation.

The Retro™, which is a mains option, avoids the need to bury a transformer. The 110/240-12 volt electronic transformer is built into the pole and is a double insulated safety isolating transformer, this changes the luminaire to an IP56 rating.

A GU10 version of this luminaire is also available for line voltage lamps.

Ordering Information

Luminaire Type

SPL - Single Pole Lite

Material/Finish

BK - Black
 BZ - Bronze
 GN - Green
 STAR - Silver Star
 WH - White
 WB - Birch
 DG - Dark Grey
 OG - Olive Green
 RG - Beige
 PR - Primrose
 COP - Copper
 SS - 316 Stainless Steel

Accessories

CJK150 - Cable Joint Kit
 LENSSTEPF - Frost Lens
 GG - Glare Guard
 HCL - Hex Cell Louvre Adaptor
 /R - Retro™ Transformer
 110/240-12 volt
 GU - GU10 option

Ordering Example: SPL SS - Single Pole Lite in 316 Stainless Steel
 SPL/R COP - Single Pole Lite Retro™ in Copper
 SPLGU COP - Single Pole Lite GU10 in Copper

HCL - Hex Cell Louvre Adaptor
 (Accessories ordered separately)

HUNZA™ PURE OUTDOOR LIGHTING

HUNZA FACTORY
 130 Felton Mathew Ave
 Glen Innes
 Auckland 1072
 New Zealand

Ph: 64-9-528 9471
 Fax: 64-9-528 9361
 hunza@hunza.co.nz
 www.hunza.co.nz

INTERNATIONAL CONTACTS:
www.hunza.co.nz/contacts.php

Specifications may change without notice.
 Manufactured in New Zealand.
 © 2011 Hunza Holdings Ltd.

Luminaire Construction

CNC machined from one of the following metals:

High corrosion resistant 63.5mm (2½") x 10mm (25/64") aluminium.
End cap - solid aluminium 63.5mm (2½") rod, with chromate substrate and high UV resistant polyester powder coat - Colours Black, Bronze, Green, Silver Star, White, Birch, Dark Green, Olive Green, Beige, Primrose.

Copper 63.5mm (2½") x 10mm (13/32"). End cap - solid copper 63.5mm (2½") rod.

316 Stainless steel 9mm (11/32")
End cap - solid 316 stainless steel 63.5mm (2½") rod.

Poles: Aluminium, Copper, 316 Stainless steel 38mm (1½") x 850mm (33½") tube.

Retro™: Pole - 38mm (1½") x 410mm (16") tube.

Transformer Pole 63.5mm (2½") x 440mm (17½").

Mounting

Pole 850mm (33½") directly mounted into the earth. Retro™ - set in concrete.

Features

Lens:
10mm (3/8") clear 'flush fit' shatter resistant glass. Lifetime Warranty.

Gaskets:
Silicone, iron impregnated 220°C (428°F).

Lamp Holder:
GU5.3 & GU10 - 350°C (662°F)
ceramic multi contact lamp holder with 250°C (480°F) teflon cables.

Accessories:

Cable Joint Kit (Cat. CJK150).
Not approved for USA/Canada.
Frosted Lens (Cat. LENSSTEPF).
Glare Guard (Cat. GG).
Hex Cell Louvre Adaptor (Cat. HCL).
Retro™ transformer 110/240-12 volt IP56 (Cat. /R).
GU10 Option (Cat. GU).

Swivel:

Aluminium and Copper luminaires 360° rotation and 0 - 90° elevation, solid brass with anti rust spring.

Stainless Steel luminaires 360° rotation and 0 - 90° elevation, full stainless steel construction.

Standards

IP56/IP66  UL1838

Luminaire Weight

12 volt: Alum 1.000kg (2lb 3oz)
Cop 2.300kg (5lb 1oz)
SS 2.100kg (4lb 10oz)
Retro™ Alum 2.100kg (4lb 10oz)
Cop 3.300kg (7lb 4oz)
SS 3.150kg (6lb 15oz)

Power Supply

HUNZA™ Inground or Wall Mount
Transformer: not included.

RETRO™ IP56

HUNZA™ 110/240-12 volt ac silicone encapsulated electronic transformer is built into the pole. Dimmable with a suitable dimmer.

USA and Canada:

HUNZA™ Wall Mount Transformer: not included.

Luminaire: supplied with

MR16 GU5.3 20, 35, 50 watt lamp max.
Retro™ MR16 GU5.3 20, 35, 50 watt lamp max.
GU10 - GU10 25 or 35 watt lamp max.

USA and Canada:

MR16 GU5.3 20 watt lamp (35 watt lamp max with glare guard fitted)
GU10 Halogen - Lamp not supplied

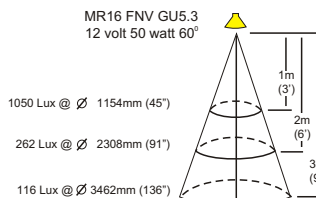
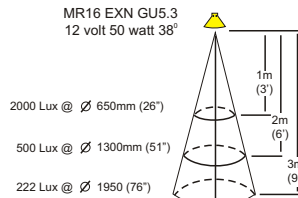
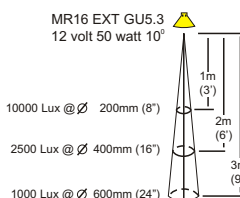
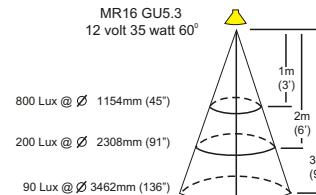
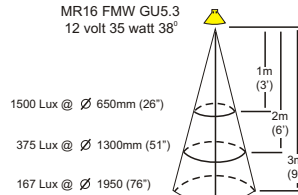
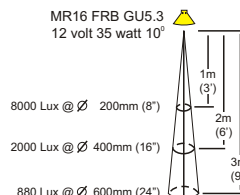
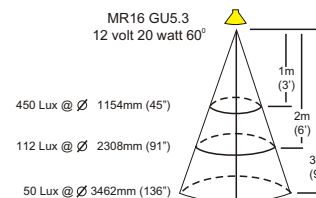
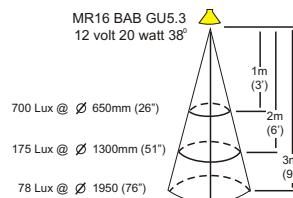
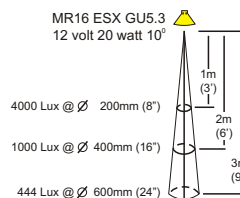

HUNZA™ PURE OUTDOOR LIGHTING

HUNZA FACTORY
130 Felton Mathew Ave
Glen Innes
Auckland 1072
New Zealand

Ph: 64-9-528 9471
Fax: 64-9-528 9361
hunza@hunza.co.nz
www.hunza.co.nz

INTERNATIONAL CONTACTS:
www.hunza.co.nz/contacts.php

Specifications may change without notice.
Manufactured in New Zealand.
© 2011 Hunza Holdings Ltd.