

# Twin Pole Lite

Cat. No. TPL

Cat. No. TPL/R

Cat. No. TPLGU

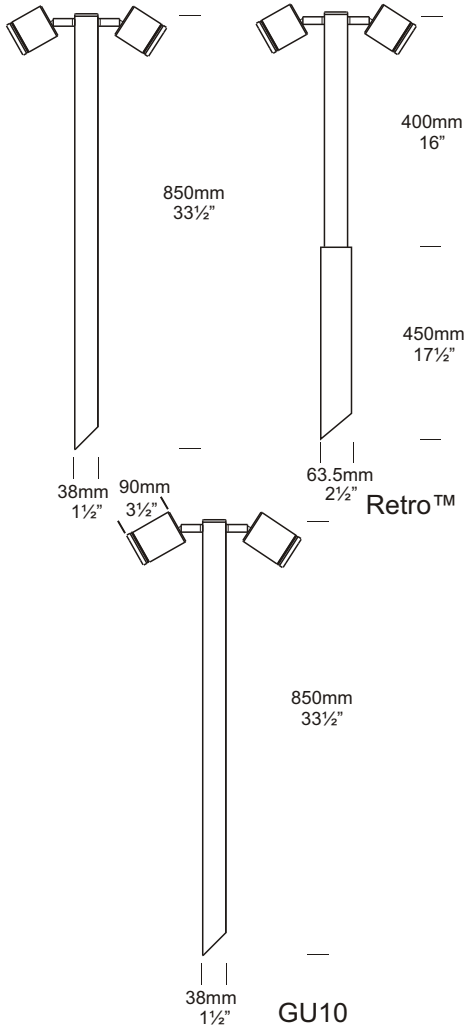

Twin Pole Lite

The Twin Pole Lite is ideal for path lighting as well as tree lighting, or the heads may be aimed downward to eliminate vertical light. The fixture has two individual spotlights which can be aimed in two entirely different directions. Each lite has fully adjustable arms allowing 360 degree rotation and 0 - 90 degree elevation.

The Retro™, which is a mains option, avoids the need to bury a transformer. The 110/240-12 volt electronic transformer is built into the pole and is a double insulated safety isolating transformer this changes the luminaire to an IP56 rating.

A GU10 version of this luminaire is also available for line voltage lamps. However, two longer luminaire bodies are needed to accommodate the longer lamps.

## Ordering Information

### Luminaire Type

TPL - Twin Pole Lite

### Material/Finish

BK - Black  
 BZ - Bronze  
 GN - Green  
 STAR - Silver Star  
 WH - White  
 WB - Birch  
 DG - Dark Grey  
 OG - Olive Green  
 RG - Beige  
 PR - Primrose  
 COP - Copper  
 SS - 316 Stainless Steel

### Accessories

CJK150 - Cable Joint Kit  
 LENSSTEPF - Frost Lens  
 GG - Glare Guard  
 HCL - Hex Cell Louvre Adaptor  
 /R - Retro™ Transformer  
 110/240-12 volt  
 GU - GU10 Option

Ordering Example: TPL SS - Twin Pole Lite in 316 Stainless Steel

TPL/R COP - Twin Pole Lite Retro™ in Copper

TPLGU COP - Twin Pole Lite GU10 in Copper

HCL - Hex Cell Louvre Adaptor  
 (Accessories ordered separately)

**HUNZA**™ PURE OUTDOOR LIGHTING

**HUNZA FACTORY**  
 130 Felton Mathew Ave  
 Glen Innes  
 Auckland 1072  
 New Zealand

Ph: 64-9-528 9471  
 Fax: 64-9-528 9361  
 hunza@hunza.co.nz  
 www.hunza.co.nz

**INTERNATIONAL CONTACTS:**  
[www.hunza.co.nz/contacts.php](http://www.hunza.co.nz/contacts.php)

Specifications may change without notice.  
 Manufactured in New Zealand.  
 © 2011 Hunza Holdings Ltd.

Ver 1.4

## Luminaire Construction

CNC machined from one of the following metals:

High corrosion resistant 63.5mm (2½") x 10mm (25/64") aluminium. End cap - solid aluminium 63.5mm (2½") rod, with chromate substrate and high UV resistant polyester powder coat - Colours Black, White, Bronze, Green, Silver Star, White, Birch, Dark Green, Olive Green, Beige, Primrose.

**Copper:** 63.5mm (2½") x 10mm (13/32"). End cap - solid copper 63.5mm (2½") rod.

**316 Stainless Steel:** 9mm (11/32"). End cap - solid 316 stainless steel 63.5mm (2½") rod.

**Poles:** Aluminium, Copper, 316 Stainless 38mm (1½") x 850mm (33½") tube.

**Retro™ Pole:** 38mm (1½") x 410mm (16") tube.

**Transformer Pole:** 63.5mm (2½") x 440mm (17½").

## Mounting

Pole 850mm (33½") directly mounted into the earth. Retro™ - set in concrete.

## Features

**Lens:**  
7mm (¼") clear flush fit shatter resistant glass. Lifetime Warranty.

**Gaskets:**  
Silicone, iron impregnated 220°C (428°F).

**Lamp Holders:**  
GU5.3 & GU10 - 350°C (662°F) ceramic multi contact lamp holder with 250°C (480°F) teflon cables.

**Accessories:**  
Cable Joint Kit (Cat. CJK150)  
Not approved for USA /Canada.  
Frosted Lens (Cat. LENSSTPEF).  
Glare Guard (Cat. GG).  
Hex Cell Louvre Adaptor (Cat. HCL).  
Retro™ transformer 110/240-12 volt (Cat. /R) IP56.  
GU10 Option (Cat. GU).

## Swivels

Aluminium and Copper luminaires 360° rotation and 0 - 90° elevation, solid brass with anti rust spring.

Stainless Steel luminaires 360° rotation and 0 - 90° elevation, full stainless steel construction.

## Standards

IP56/IP66  UL1838

## Luminaire Weight

12 volt: Alum 1.200kg (2lb 10oz)  
Cop 3.500kg (7lb 7oz)  
SS 2.800kg (6lb 2oz)  
Retro™: Alum 2.300kg (5lb 1oz)  
Cop 4.300kg (8lb 9oz)  
SS 3.600kg (7lb 11oz)

## Power Supply

HUNZA™ Inground or Wall Mount Transformer: not included.

## RETRO™ IP56

HUNZA™ 110/240-12 volt ac potted electronic transformer is built into the pole. Dimmable with a suitable dimmer.

## USA and Canada:

HUNZA™ Wall Mount Transformer: not included.

## Luminaire: supplied with

MR16 GU5.3 2 x 20, 35 watt lamp max.  
Retro™ MR16 GU5.3 20, 35, 50 watt Lamps max.  
GU10 - GU10 25 or 35 watt lamps max.

## USA and Canada:

MR16 GU5.3 2 x 20 watt lamp max. 35 watt lamp max with glare guard fitted  
GU10 Halogen - Lamps not supplied

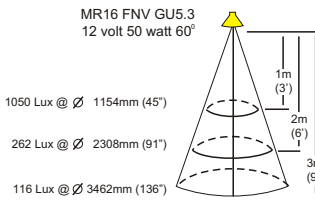
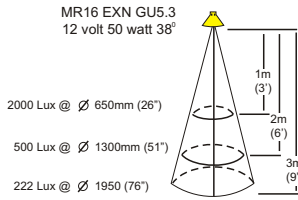
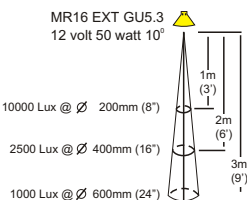
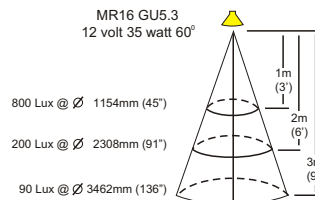
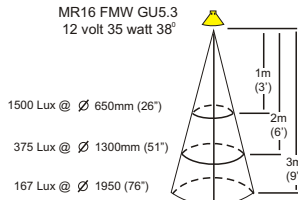
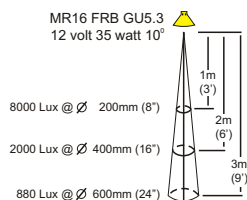
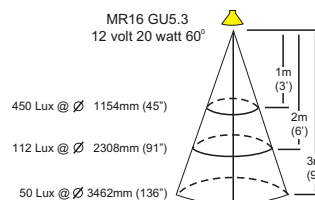
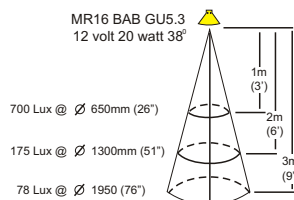
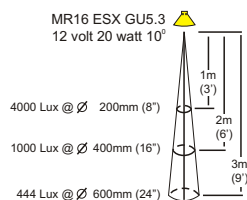

**HUNZA™** PURE OUTDOOR LIGHTING

**HUNZA FACTORY**  
130 Felton Mathew Ave  
Glen Innes  
Auckland 1072  
New Zealand

**Ph: 64-9-528 9471**  
**Fax: 64-9-528 9361**  
hunza@hunza.co.nz  
www.hunza.co.nz

**INTERNATIONAL CONTACTS:**  
www.hunza.co.nz/contacts.php

Specifications may change without notice.  
Manufactured in New Zealand.  
© 2011 Hunza Holdings Ltd.

Ver 1.4