

# Twin Sign Lite

Cat. No. TSGNL

Cat. No. TSGNLGU

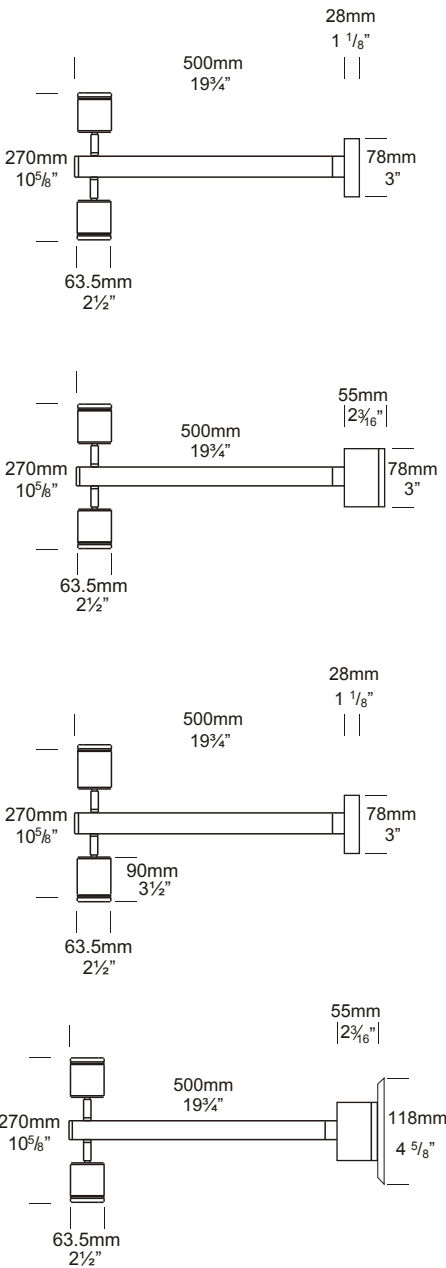

The Twin Sign Lite is for lighting signs, wall displays, building highlights, and external barbeques. The fully adjustable heads are mounted on the end of a 500mm (19.5") arm, allowing 360 degree rotation and 90 degree elevation.

Available in 12 volt or with a built in 110 or 240 volt transformer (Retro™) option. This luminaire is machined from a choice of 10mm thick aluminium with a UV stable powder coated finish, solid copper or 316 stainless steel with a clear, tempered, flush glass lens and high temperature silicon gaskets.

A GU10 version of this luminaire is also available for line voltage lamps. However, two longer luminaire bodies are needed to accommodate the longer lamps.

## Ordering Information

### Luminaire Type

TSGNL - Sign Lite

### Material/Finish

BK - Black  
 BZ - Bronze  
 GN - Green  
 STAR - Silver Star  
 WH - White  
 WB - Birch  
 DG - Dark Grey  
 OG - Olive Green  
 RG - Beige  
 PR - Primrose  
 COP - Copper  
 SS - 316 Stainless Steel

### Accessories

CJK150 - Cable Joint Kit  
 LENSSTEPF - Frost Lens  
 GG - Glare Guard  
 HCL - Hex Cell Louvre Adaptor  
 /R - Retro™ Transformer  
 110/240-12 volt  
 GU - GU10 Option

Ordering Example: TSGNL SS - Twin Sign Lite 316 Stainless Steel

TSGNLGU COP - Twin Sign Lite GU10 Copper

HCL - Hex Cell Louvre Adaptor  
 (Accessories ordered separately)

**HUNZA**™ PURE OUTDOOR LIGHTING

**HUNZA FACTORY**  
 130 Felton Mathew Ave  
 Glen Innes  
 Auckland 1072  
 New Zealand

Ph: 64-9-528 9471  
 Fax: 64-9-528 9361  
 hunza@hunza.co.nz  
 www.hunza.co.nz

**INTERNATIONAL CONTACTS:**  
[www.hunza.co.nz/contacts.php](http://www.hunza.co.nz/contacts.php)

Specifications may change without notice.  
 Manufactured in New Zealand.  
 © 2011 Hunza Holdings Ltd.

## Luminaire Construction

CNC machined from one of the following metals:

High corrosion resistant 63.5mm (2½") x 10mm (25/64") aluminium. End cap - solid aluminium 63.5mm (2½") rod, with chromate substrate and high UV resistant polyester powder coat - Colours Black, Bronze, Green, Silver Star, White, Birch, Dark Green, Olive Green, Beige, Primrose.

**Copper** 63.5mm (2½") x 10mm (13/32"). End cap - solid copper 63.5mm (2½") rod.

**316 Stainless Steel** 63.5mm (2½") x 9mm (11/32"). End cap - solid 316 stainless steel 63.5mm (2½") rod.

**Poles** Aluminium, Copper, 316 Stainless 38mm (1½") x 500mm (19¾") tube.

## Mounting

12 volt: the luminaire is mounted to the wall using two 316 stainless screws through a shallow base 16mm (5/8") in depth. A Wall Box Adaptor Plate is available as an accessory to fit 3.0 and 4.0 junction boxes for USA/Canada.

Retro™ 110/240-12 volt: a mounting plate is fixed to the wall using two screws, the luminaire is fitted to the mounting plate.

## Features

**Lens:**  
10mm (3/8") clear flush fit shatter resistant glass. Lifetime Warranty.

**Gaskets:**  
Silicone, iron impregnated 220°c (428°f).

**Lamp Holder:**  
GU5.3 & GU10 - 350°c (662°f) ceramic multi contact lamp holder with 250°c (480°f) teflon cables.

**Accessories:**  
Cable Joint Kit (Cat. CJK150).  
Frosted Lens (Cat. LENSSTEPF).  
Glare Guard (Cat. GG).  
Hex Cell Louvre Adaptor (Cat. HCL).  
Retro™ transformer 110/240-12 volt (Cat. /R) IP66.  
GU10 Option (Cat. GU).

**Swivel**  
**Aluminium** and **Copper** luminaires 360° rotation and 0 - 90° elevation, solid brass with anti rust spring.

**Stainless Steel** luminaires 360° rotation and 0 - 90° elevation, full stainless steel construction.

## Standards

IP56/IP66  UL1838

## Luminaire Weight

12 volt: Alum 1.2kg (2lb 10oz)  
Cop 2.840kg (6lb 4oz)  
SS 2.120kg (4lb 11oz)  
Retro™: Alum 1.7kg (3lb 12oz)  
Cop 3.900kg (8lb 9oz)  
SS 3.555kg (7lb 13oz)

## Power Supply

HUNZA™ Inground or Wall Mount Transformer: not included.

## RETRO™

HUNZA™ 110/240-12 volt ac potted electronic transformer is built into the base.  
Dimmable with a suitable dimmer.

## USA and Canada:

HUNZA™ Wall Mount Transformer: not included.

## Luminaire: supplied with

MR16 GU5.3 2 x 20, 35 watt lamp max.  
GU10 - GU10 25 or 35 watt lamps max.

## USA and Canada:

MR16 GU5.3 2 x 20 watt lamp max.  
When glare guard fitted lamp wattage can be increased to 35 watt.  
GU10 Halogen - Lamps not supplied

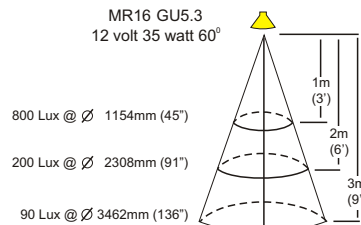
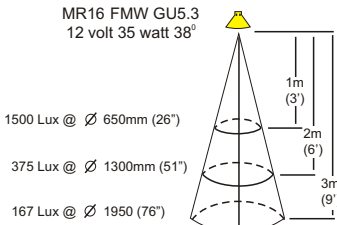
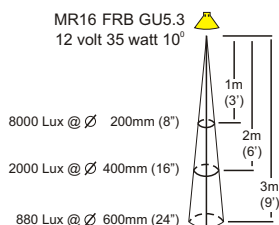
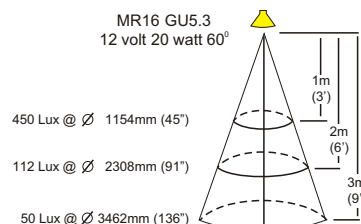
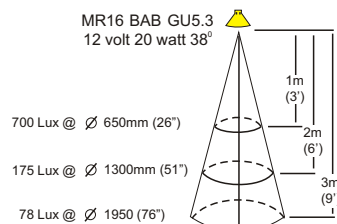
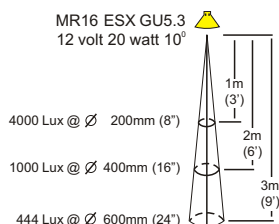

**HUNZA™** PURE OUTDOOR LIGHTING

**HUNZA FACTORY**  
130 Felton Mathew Ave  
Glen Innes  
Auckland 1072  
New Zealand

Ph: 64-9-528 9471  
Fax: 64-9-528 9361  
hunza@hunza.co.nz  
www.hunza.co.nz

**INTERNATIONAL CONTACTS:**  
www.hunza.co.nz/contacts.php

Specifications may change without notice.  
Manufactured in New Zealand.  
© 2011 Hunza Holdings Ltd.