

# HUNZA™ PURE OUTDOOR LIGHTING

## Pole Flood ULTRA

PROJECT: \_\_\_\_\_

TYPE: \_\_\_\_\_

SOURCE: \_\_\_\_\_

NOTES: \_\_\_\_\_

### SPECIFICATIONS



\*custom pole lengths range from 50mm (60") to 2000mm (6ft 8")

<b>LED Chip</b>	Cree CXA 2540 field replaceable LED board
<b>Luminaire Output</b>	5000 Lumens @ 1400 (52watts), Delivered from Luminaire with unobstructed beam.
<b>Lumens Per Watt</b>	90 Lumens minimum @ 52 watts, Delivered from Luminaire with unobstructed beam
<b>CRI (3000K)</b>	80 Standard, 90+ Optional
<b>Colour Temperatures</b>	2700K, 3000K, 4000K
<b>Beam Angles</b>	13, 22, 33, 51
<b>Ingress Protection</b>	IP66
<b>Warranty</b>	Electronics = 5 years Body Aluminium = 5 years
<b>Standards</b>	BS/EN 60598.2.2 cUL 1598 CE

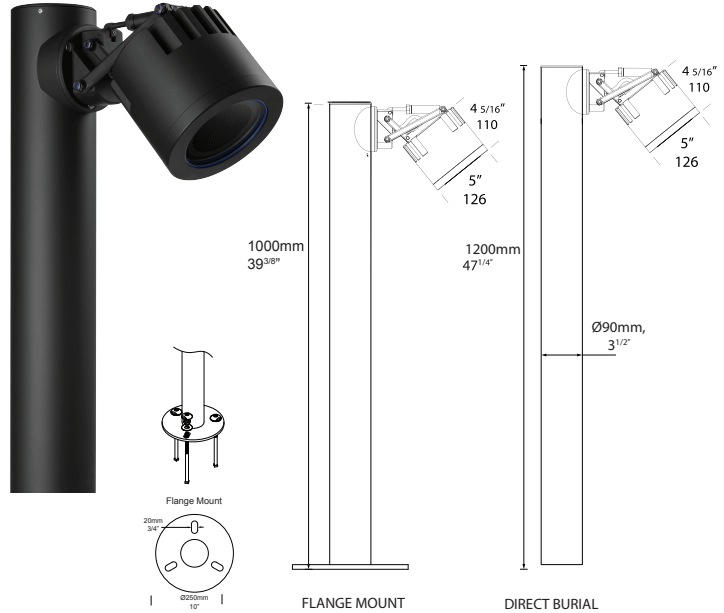

### PRODUCT CONFIGURATION

Please fill in appropriate codes into boxes provided

Cat. No. PFL/U

Luminaire	Power	Material/ Finish	Beam	Colour	Accessories
<input type="text" value="PFL/U"/>	<input type="text"/>	<input type="text"/>	<input type="text"/>	<input type="text"/>	<input type="text"/>
<input type="text" value="PFLFM/U"/>					
Pole Flood flange mount					
<input type="text" value="SR"/>	<input type="text"/>	<input type="text"/>	<input type="text"/>	<input type="text"/>	<input type="text"/>
<input type="text" value="R"/>	<input type="text"/>	<input type="text"/>	<input type="text"/>	<input type="text"/>	<input type="text"/>
SERIES REMOTE: Constant current driver (included) Fixture require 37vdc @ 1400mA maximum					
RETRO 110-277vac DRIVER: Constant current driver (included) Input: 120,240,277 volts Output: 60 watts total 37vdc @ 140mA 0-10 volt dimming					
		ALUMINIUM			
		EBK BLACK	22 22°	2 2700K	HCL/U HEX CELL LOUVRE
		EBZ BRONZE	33 33°	3 3000K	SNT/U SNOOT
		EOGR OLIVE GREEN	51 51°	4 4000K	GG/U GLARE GUARD
		EWH WHITE		39 3000K, 90+ CRI	GS/U GLARE SHEILD
		EWB WHITE BIRCH	13 13° Requires Lens Ring extension		LF FROSTED LENS
		EDG DARK GREY			MC MOUNTING CAGE
		ESTAR SILVER STAR			CJK CABLE JOINT KIT
		ECT CORTEN			DN DOME NUT
					DNUSA DOME NUT USA

54mm 2 1/8"

ADDITIONAL COMMENTS:

# LUMINAIRE CONSTRUCTION

## CNC machined from one of the following metals:

Body - solid high corrosion resistant 127mm (5") aluminium rod.  
 Base - high corrosion resistant 127mm (5") x 3.18mm (1/8") aluminium tube.  
 Finished with chromate substrate, Epoxy layer and a UV resistant polyester powder coat colour.  
 Fixings and Mechanism - made from 316 Stainless Steel

## Colours:

Black, Bronze, Silver Star, White, Birch, Olive Green, Dark Grey, Corten.

## Step Lens:

12mm (1/2") Extra clear, low iron, shatter resistant glass.  
 Lifetime warranty

## Gaskets:

Silicone, iron impregnated 220°C (428°F)

## Cable:

Water resistant rubber

## Mounting:

Pole is set directly into concrete.  
 For flange mounting please refer to the Hunza website for mounting instructions.  
 Dome Nut - for use with M12 J-bolts.  
 Dome Nut USA - for use with 1/2" UNC 13 TPI J-bolts.

## Luminaire Weight:

5kg (11lbs)- Head only

## ACCESSORIES

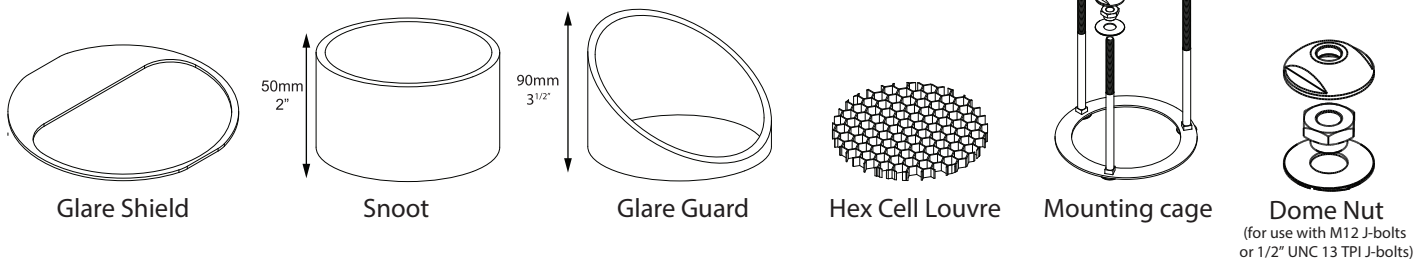

## BEAM ANGLES

High efficiency Reflectors. Feild replaceable

IES files available for download: [www.hunzalighting.com/download.php](http://www.hunzalighting.com/download.php)

Lamp=4 999 lm  
 Max=42 169.6 cd  
 Power=61 W

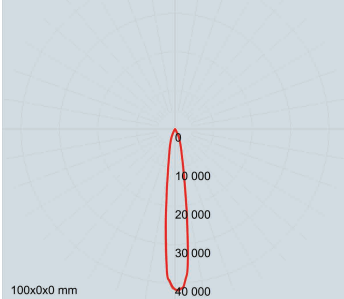

13° FWHM REFLECTOR

Lamp=5 336 lm  
 Max=20 451.9 cd  
 Power=61 W

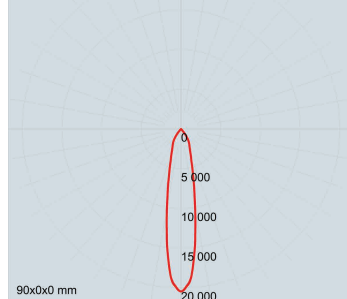

22° FWHM REFLECTOR

Lamp=5 411 lm  
 Max=8 582.4 cd  
 Power=61 W

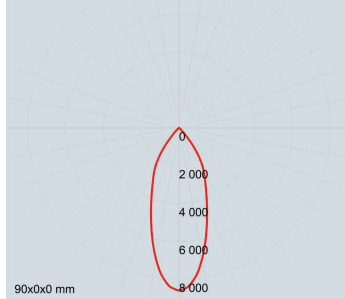

33° FWHM REFLECTOR

Lamp=5 503 lm  
 Max=7 010.6 cd  
 Power=61 W

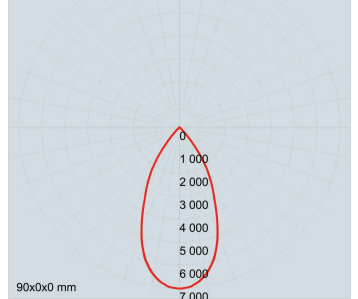

51° FWHM REFLECTOR

## WIRING GUIDE

available for download: [www.hunzalighting.com/download.php](http://www.hunzalighting.com/download.php)

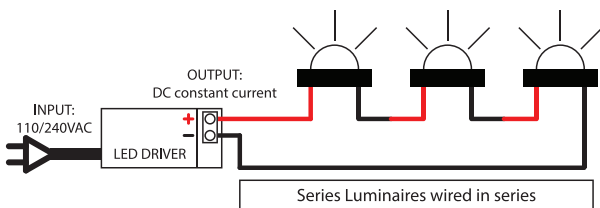

Series Luminaires wired in series

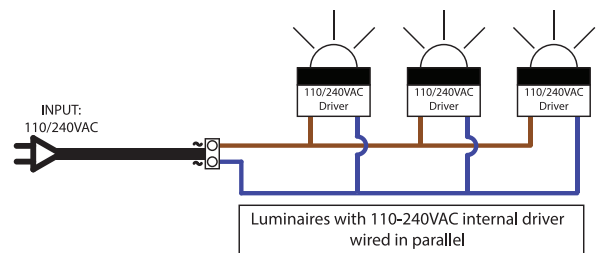

Luminaires with 110-240VAC internal driver wired in parallel

Diagrams are a guide only, wire colours and polarity may change depending on fixture and country