

Pillar Lite ULTRA

PROJECT: _____

TYPE: _____

SOURCE: _____

NOTES: _____

SPECIFICATIONS



LED Chip	Cree CXA 2540 field replaceable LED board
Luminaire Output (per end)	2800 Lumens @ 700 (26watts), Delivered from Luminaire with unobstructed beam.
Lumens Per Watt	100 Lumens minimum @ 52 watts, Delivered from Luminaire with unobstructed beam
CRI (3000K)	80 Standard, 90+ Optional
Colour Temperatures	2700K, 3000K, 4000K
Beam Angles	13, 22, 33, 51
Ingress Protection	IP66
Warranty	Electronics = 5 years Body Aluminium = 5 years
Standards	BS/EN 60598.2.2 cUL 1598 CE

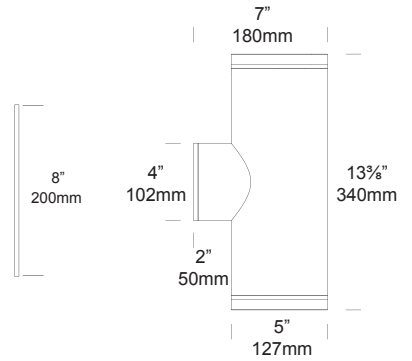

PRODUCT CONFIGURATION

Please fill in appropriate codes into boxes provided

Cat. No. PIL/U

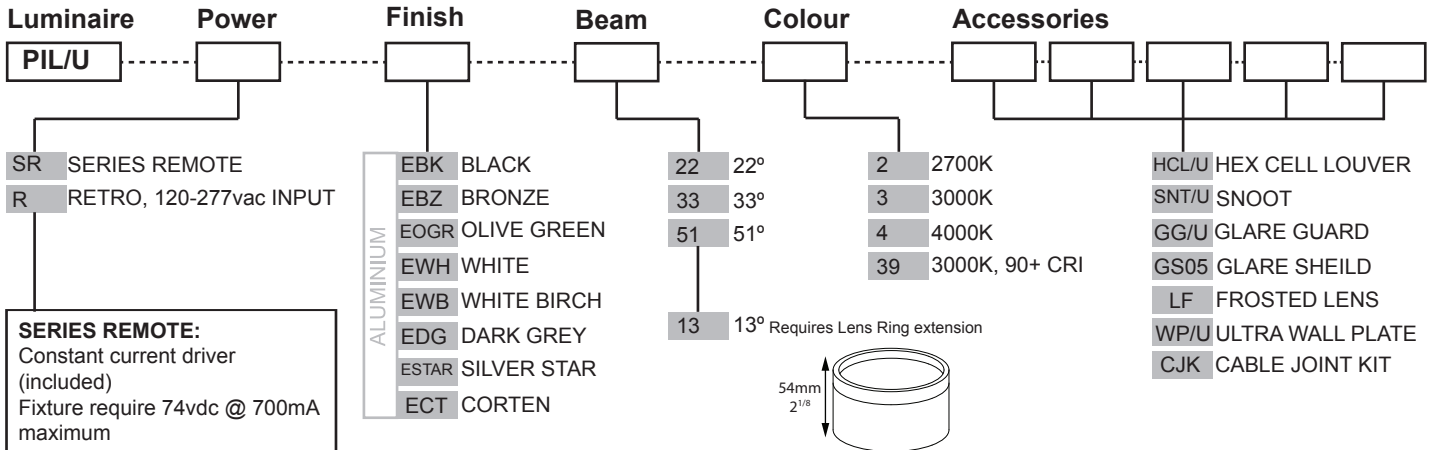

SERIES REMOTE:
Constant current driver (included)
Fixture require 74vdc @ 700mA maximum

**RETRO
110-277vac DRIVER:**
Constant current driver (included)
Input: 120,240,277 volts
Output: 60 watts total
74vdc @ 700mA
0-10 volt dimming

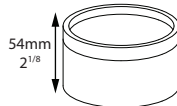

ADDITIONAL COMMENTS: _____

LUMINAIRE CONSTRUCTION

CNC machined from one of the following metals:

Body - solid high corrosion resistant 127mm (5") aluminium rod.
 Base - high corrosion resistant 127mm (5") x 3.18mm (1/8") aluminium tube.
 Finished with chromate substrate, Epoxy layer and a UV resistant polyester powder coat colour.
 Fixings and Mechanism - made from 316 Stainless Steel

Colours:

Black, Bronze, Silver Star, White, Birch, Olive Green, Dark Grey, Corten.

Step Lens:

12mm (1/2") Extra clear, low iron, shatter resistant glass.
 Lifetime warranty

Gaskets:

Silicone, iron impregnated 220°C (428°F)

Cable:

Water resistant rubber

Mounting:

The mounting plate is fixed to the surface using three stainless screws. The luminaire is then fixed to the mounting plate

Luminaire Weight:

8kg (17lbs 10oz)

ACCESSORIES

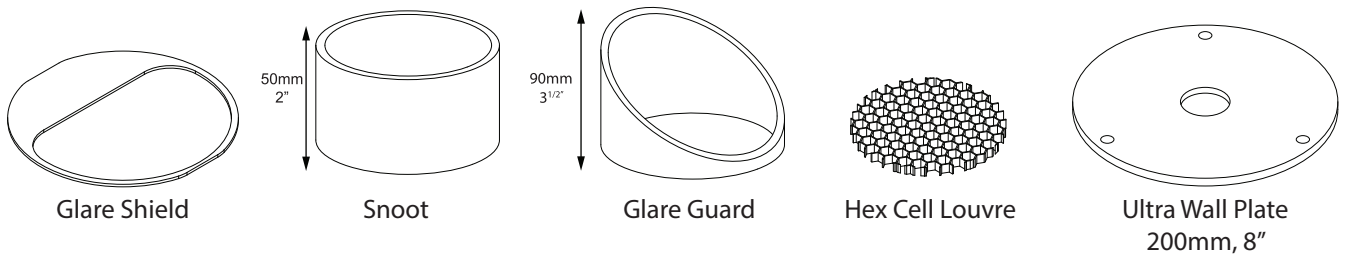

BEAM ANGLES

High efficiency Reflectors. Feild replaceable

IES files available for download: www.hunzalighting.com/download.php

Lamp=4 999 lm
 Max=42 169.6 cd
 Power=61 W

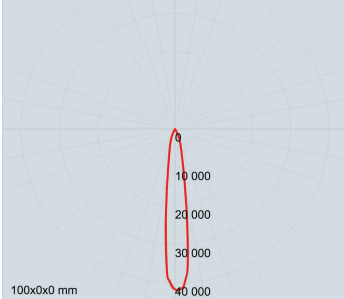

13° FWHM REFLECTOR

Lamp=5 336 lm
 Max=20 451.9 cd
 Power=61 W

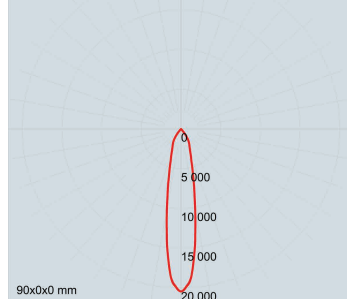

22° FWHM REFLECTOR

Lamp=5 411 lm
 Max=8 582.4 cd
 Power=61 W

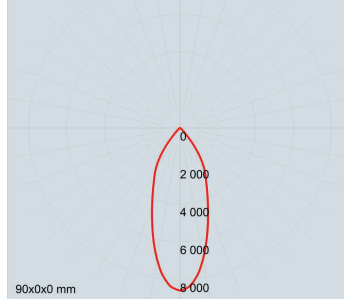

33° FWHM REFLECTOR

Lamp=5 503 lm
 Max=7 010.6 cd
 Power=61 W

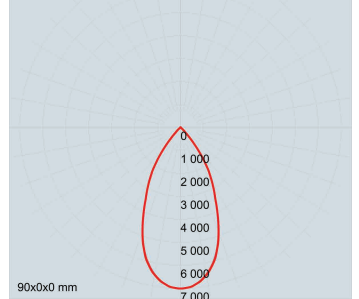

51° FWHM REFLECTOR

WIRING GUIDE

available for download: www.hunzalighting.com/download.php

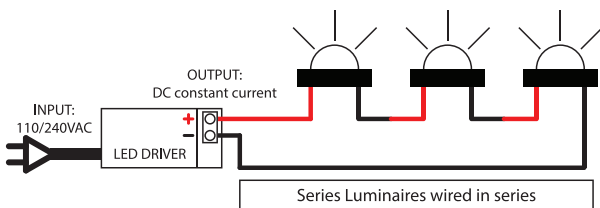

Series Luminaires wired in series

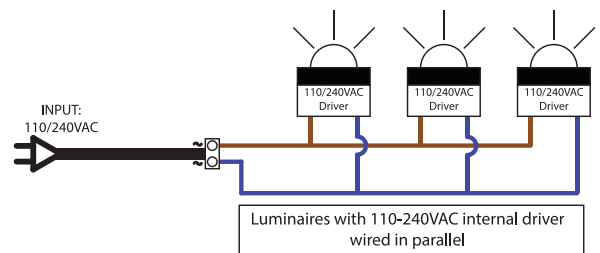

Luminaires with 110-240VAC internal driver wired in parallel

Diagrams are a guide only, wire colours and polarity may change depending on fixture and country

Specifications may change without notification

Aug 2017