

Bollard round ARCH

PROJECT: _____

TYPE: _____

SOURCE: _____

NOTES: _____

SPECIFICATIONS



LED Chip	Cree CXA 1830 field replaceable LED board
Luminaire Output	3000 Lumens @ 700mA (26watts), delivered from luminaire with unobstructed beam.
Lumens Per Watt	100 Lumens minimum @ 26 watts, delivered from luminaire with unobstructed beam
CRI (3000K)	80+ Standard, 90+ Optional
Colour Temperatures	2700K, 3000K, 4000K
Beam Angles	TYPE 2, TYPE 4 asymmetric
Ingress Protection	IP66
Warranty	Electronics = 5 years Body Aluminium = 5 years
Standards	BS/EN 60598.2.2 cUL 1598 CE

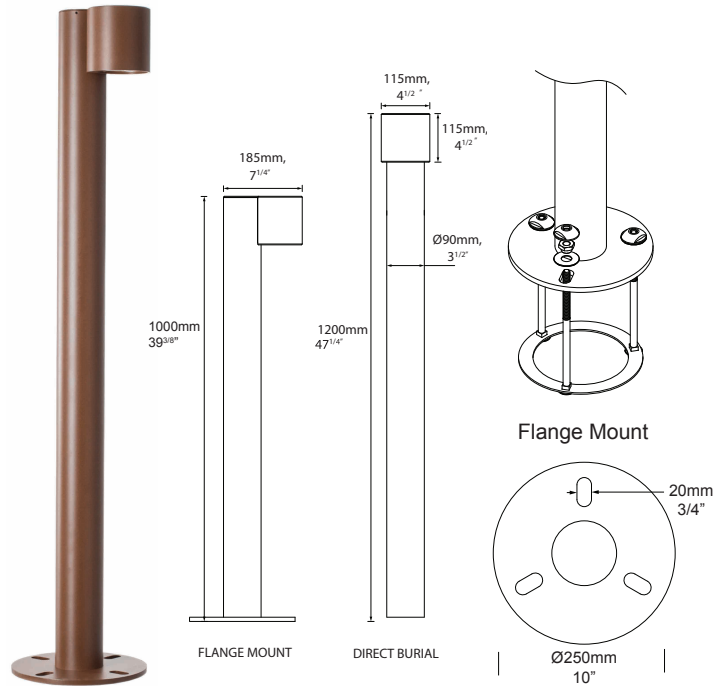

PRODUCT CONFIGURATION

Please fill in appropriate codes into boxes provided

Cat. No. ARCR

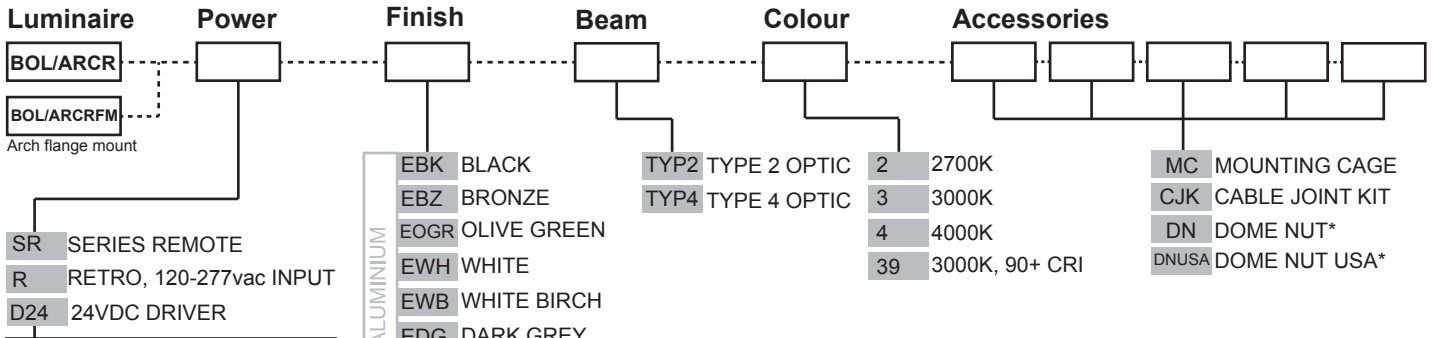

SERIES REMOTE DRIVER:
 Constant current driver
 LFOXGHG Individual fixtures require vdc @ 0mA maximum.

RETRO 110-2 vac DRIVER:
 RQVWDQWEUHQWGULYHU
 LQFOGHG
 Input: MROWV
 Output: ZDWWVWRWDOvdc, 0mA-10 volt dimming

24VDC DRIVER:
 Input: 24vdc.
 Output: vdc @ 700mA constant current (non dimming).
 no

*Only available for Flange Mount version

ADDITIONAL COMMENTS: _____

LUMINAIRE CONSTRUCTION

CNC machined from one of the following metals:

Aluminium

Body: High corrosion resistant 115mm (4^{1/2}") aluminium rod.
 Tube: high corrosion resistant 90mm (3^{1/2}") x 3.18mm (1/8") aluminium tube.
 Finished with chromate substrate, Epoxy layer and a UV resistant polyester powder coat colour.
 Fixings and Mechanism - made from 316 stainless steel.

Colours:

Black, Bronze, Silver Star, White, White Birch, Olive Green, Dark Grey, Corten.

Step Lens:

Extra clear optical silicone TIR.

Gaskets:

Silicone, iron impregnated 220°C (428°F)

Cable:

Water resistant rubber

Mounting:

Pole is set directly into concrete.
 For flange mounting please refer to the Hunza website for mounting instructions.
 Dome Nut - for use with M12 J-bolts.
 Dome Nut USA - for use with 1/2" UNC 13 TPI J-bolts.

Luminaire Weight:

6kg (13lbs 4oz) without flange

ACCESSORIES

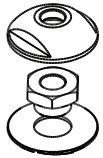

Dome Nut

(for use with M12 J-bolts or 1/2" UNC 13 TPI J-bolts)

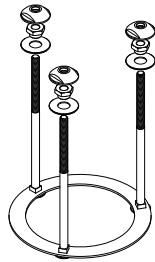

Mounting cage

BEAM ANGLES

High efficiency Reflectors. Feild replaceable

IES files available for download: hunzalighting.com/downloads

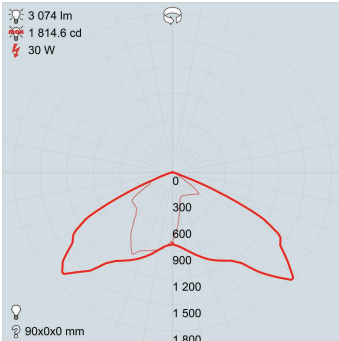

TYPE 2 OPTIC

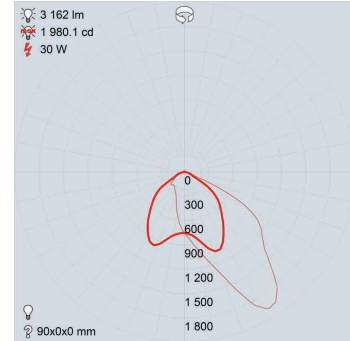

TYPE 4 OPTIC

WIRING GUIDE

Available for download: hunzalighting.com/downloads

Series/remote driver

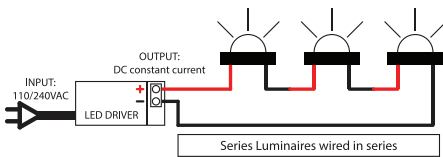

Diagrams are a guide only, wire colours and polarity may change depending on fixture and country

110/240v integral driver

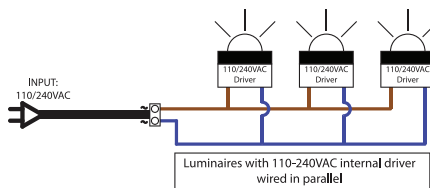

24vdc integral driver

