

PROJECT:
TYPE:
SOURCE:
NOTES:

PURELED SPECIFICATIONS

LED Chip	Cree XHP-50-2 Plug and Play field replaceable LED board
Luminaire Output	600 Lumens @ 1050mA (6 watts), 420 Lumens @ 700mA (4 watts), 240 Lumens @ 350mA (2 watts), delivered from luminaire with unobstructed beam.
Lumens Per Watt	100 Lumens minimum @ 6 watts, delivered from luminaire with unobstructed beam
CRI (3000K)	90+
Colour Temperatures	2700K, 3000K, 4000K
Beam Angles	15, 25, 38, 60
Ingress Protection	IP66
Warranty	Electronics = 5 years Body Cop/ SS = 10 years Body Aluminium = 5 years
Standards	AS/NZS 61046, EN60598 cUL 1838, 2108, 1598 CSA 22.2 No. 250.7, No. 250.0-08, No. 250.0 CE

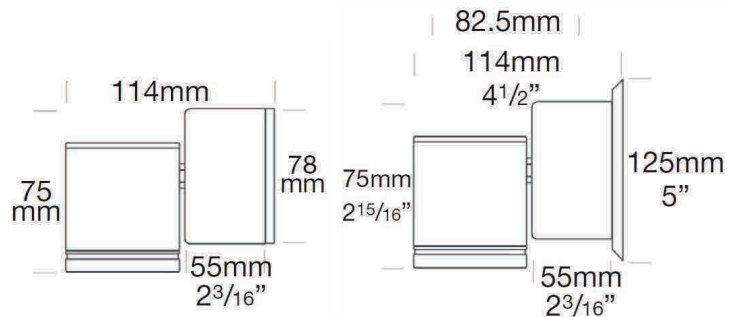
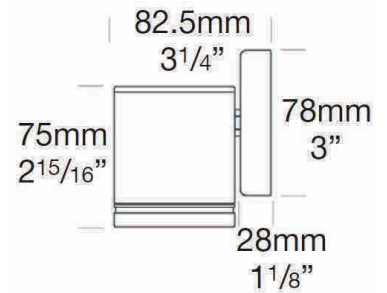

Retro

Retro USA/Canada

PRODUCT CONFIGURATION

Please fill in appropriate codes into boxes provided

Cat. No. DL/L

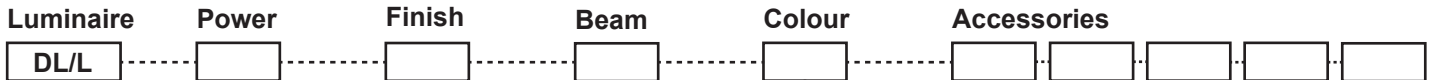

- S SERIES, REMOTE DRIVER
- D3 12VAC, 2W INTEGRAL
- D7 12VAC, 4W INTEGRAL
- D10 12VAC, 6W INTEGRAL
- R RETRO, 110/240V DRIVER

- | | | | | |
|-----------|-------|-----------------|----|-----|
| ALUMINIUM | EBK | BLACK | 15 | 15° |
| | EBZ | BRONZE | 25 | 25° |
| | EOGR | OLIVE GREEN | 38 | 38° |
| | EWH | WHITE | 60 | 60° |
| | EWB | WHITE BIRCH | | |
| | EDG | DARK GREY | | |
| | ESTAR | SILVER STAR | | |
| | ECT | CORTEN | | |
| | COP | SOLID COPPER | | |
| | SS | STAINLESS STEEL | | |

- 2 2700K
- 3 3000K
- 4 4000K

- HCL HEX CELL LOUVRE
- SNT SNOOT
- GG GLARE GUARD
- LF FROSTED LENS
- WBAP WALL BOX ADAPTOR
- CJK CABLE JOINT KIT
- TLTM TILTING MODULE

SERIES, REMOTE DRIVER REQUIRED:

Constant current driver
Individual fixtures require 6vdc @ 1050mA maximum

12VAC INTEGRAL DRIVER:
Hunza integrated plug and play driver (included)
Input: 9-15VAC.
Output: 6vdc @ D3=350mA, D7=700mA, D10=1050mA (1050mA limited to ≤ 40°C (104°F) ambient temperature in stainless steel)

110/240VAC RETRO DRIVER:
Input: 120/240vac, 5 watt total (driver included)
Output: 6vdc, 700mA
0-10 volt dimming (USA - non dimming)

OTHER LAMP OPTIONS:

- DL/H - MR16 Halogen 12V Lamp
- DL/SL - MR16 LED Retrofit 12V Lamp (lamps vary by market - please refer to supplier for details)
- DL/GUH - GU10 120/240V Halogen Lamp (body length increases for all GU10 lamps)
- DL/GUSL - GU10 LED Retrofit 120/240V Lamp (lamps vary by market - please refer to supplier for details)

[Click here for halogen specification sheet](#)

[Click here for 240v Remote Power Supply Guidance Charts](#)

[Click here for USA Remote Power Supply Guidance Charts](#)

LUMINAIRE CONSTRUCTION

CNC machined from one of the following metals:

Aluminium:

Body: high corrosion resistant 63.5mm (2^{1/2}") x 10mm (3/8") aluminium.

End cap: solid aluminium 63.5mm (2^{1/2}") rod.

Base and Mounting Plate (Retro™): hand spun 2mm aluminium disk. Base cast from virgin high corrosion resistant CC401 low copper aluminium alloy chromate substrate and high UV resistant polyester powder coat.

Colours:

Black, Bronze, Silver Star, White, White Birch, Olive Green, Dark Grey, Corten.

Copper:

Body: 63.5mm (2^{1/2}") x 10mm (3/8") rod.

End cap: solid copper 63.5mm (2^{1/2}") rod.

Base and Mounting Plate (Retro™): handspun 2mm (5/64") copper disk and forged brass

316 Stainless Steel:

Body: 63.5mm (2^{1/2}") x 10mm (3/8").

End cap: solid 316 stainless steel 63.5 (2^{1/2}") rod.

Base and Mounting Plate: investing cast and CNC machined 316 stainless steel.

Step Lens:

10mm (3/8") extra clear, low iron, shatter resistant glass.

Lifetime warranty

Gaskets:

Silicone, iron impregnated 220°C (428°F)

Mounting:

12 volt: the luminaire is mounted to the wall using two 316 stainless screws through a shallow base 28mm (1^{1/8}") in depth.

Retro™ (110/240-12volt): a mounting plate is fixed to the wall using two screws and the luminaire is fitted to the mounting plate.

Luminaire Weight:

Low voltage

Alum: 0.460kg (1lb)

Cop: 1.200kg (2lb 10oz)

SS: 1.080kg (2lb 6oz)

Retro™

Alum: 0.780kg (1lb 11oz)

Cop: 1.680kg (3lb 11oz)

SS: 1.505kg (3lb 5oz)

ACCESSORIES

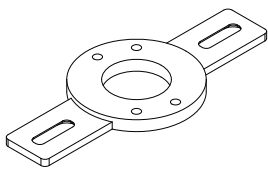

Wall Box Adaptor

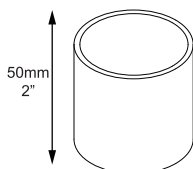

Snoot

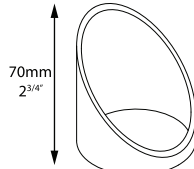

Glare Guard

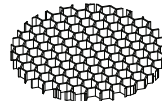

Hex Cell Louvre

BEAM ANGLES

High efficiency PMMA TIR lenses. Field replaceable

IES files available for download: hunzalighting.com/downloads

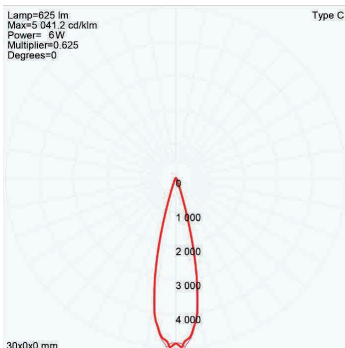

15° FWHM TIR

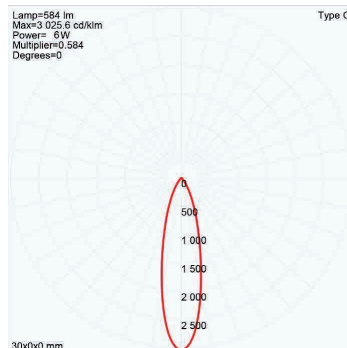

25° FWHM TIR

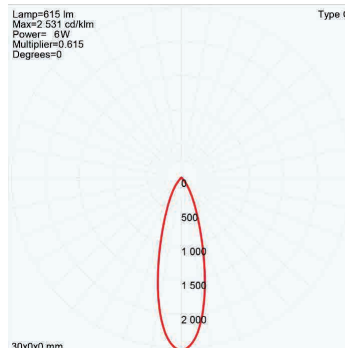

38° FWHM TIR

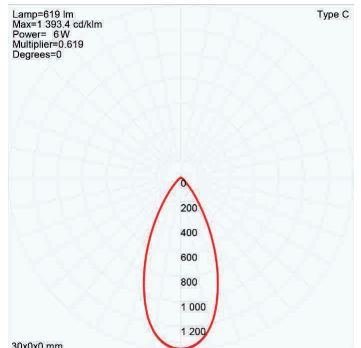

60° FWHM TIR

WIRING GUIDE

Series/remote driver

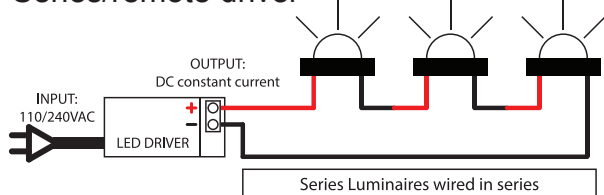

Diagrams are a guide only, wire colours and polarity may change depending on fixture and country

Available for download: hunzalighting.com/downloads

12v integral driver

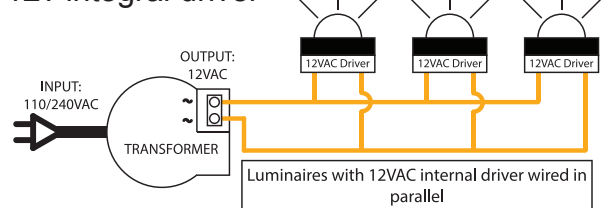

Specifications may change without notification

Aug 2017