

## Euro Step Lite

PROJECT:
TYPE:
SOURCE:
NOTES:

### PURELED SPECIFICATIONS

<b>LED Chip</b>	Cree XHP-50-2 Plug and Play field replaceable LED board
<b>Luminaire Output</b>	420 Lumens @ 700mA (4 watts), 240 Lumens @ 350mA (2 watts), delivered from luminaire with unobstructed beam.
<b>Lumens Per Watt</b>	105 Lumens @ 4 watts minimum, delivered from luminaire with unobstructed beam
<b>CRI (3000K)</b>	90+
<b>Colour Temperatures</b>	2700K, 3000K, 4000K
<b>Beam Angles</b>	15, 25, 38, 60
<b>Ingress Protection</b>	IP67
<b>Warranty</b>	Electronics = 5 years Body Cop/ SS = 10 years
<b>Standards</b>	AS/NZS 61046 cUL 1838, 2108 CSA C22.2 No. 250.7, No. 250.0-08 CE

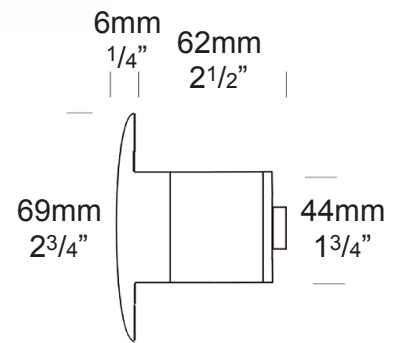

### PRODUCT CONFIGURATION

Please fill in appropriate codes into boxes provided

Cat. No. ESL/L

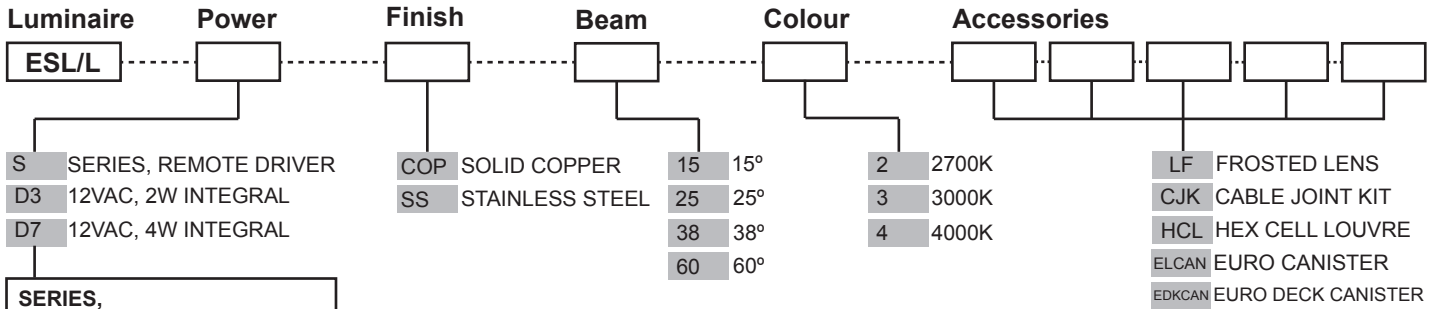

**SERIES, REMOTE DRIVER REQUIRED:**  
Constant current driver  
Individual fixtures require 6vdc @ 700mA maximum

**12VAC INTEGRAL DRIVER:**  
Hunza integrated Plug and Play Driver (included)  
Input: 12VAC, 5watt total.  
Output: 6vdc @ D3=350mA, D7=700mA

**OTHER LAMP OPTIONS:**  
ESL/H - MR11 Halogen 12V Lamp  
ESL/M11L - MR11 LED Retrofit 12V Lamp (lamps vary by market - please refer to supplier for details)

[Click here for halogen specification sheet](#)

[Click here for 240v Remote Power Supply Guidance Charts](#)

[Click here for USA Remote Power Supply Guidance Charts](#)

# LUMINAIRE CONSTRUCTION

**CNC machined from one of the following metals:**

**Copper:**

Body: 45.5mm (1<sup>3/4</sup>" ) copper rod.  
Flange: 70mm (3<sup>1/2</sup>" ) solid copper rod.

**316 Stainless Steel**

Body: 45.5mm (1<sup>3/4</sup>" ) stainless steel rod.  
Flange: 70mm (3<sup>1/2</sup>" ) solid 316 stainless steel rod.

**Mounting:**

The Euro Step Lite is fixed in place using a mounting canister. There are no mounting screws in the flange to spoil aesthetics of the luminaire.

**Luminaire Weight:**

Cop: 0.480kg (1lb 1oz)  
SS: 0.415kg (15oz)

**Lens:**

6mm (1/4") extra clear low iron flush fit shatter resistant glass. Add Hex Cell Louvre accessory for glare control.  
Lifetime Warranty.

**Gaskets:**

Silicone, iron impregnated 220°C (428°F)

## ACCESSORIES

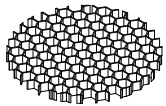

Hex Cell Louvre



Euro Canister

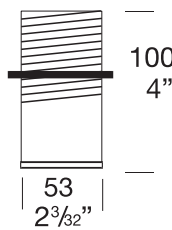

Euro Deck Canister

## BEAM ANGLES

High efficiency PMMA TIR lenses. Field replaceable

IES files available for download: [hunzalighting.com/downloads](http://hunzalighting.com/downloads)

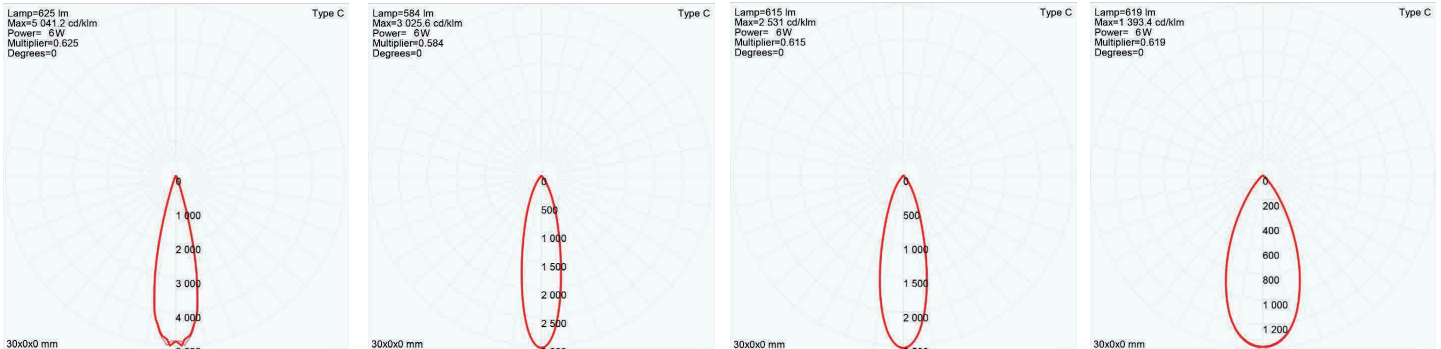

15° FWHM TIR

25° FWHM TIR

38° FWHM TIR

60° FWHM TIR

## WIRING GUIDE

Series/remote driver

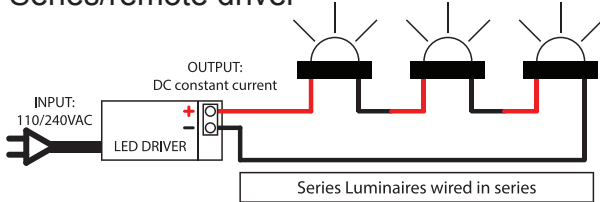

Available for download: [hunzalighting.com/downloads](http://hunzalighting.com/downloads)

12v integral driver

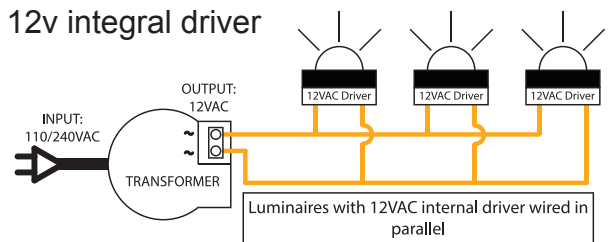

Diagrams are a guide only, wire colours and polarity may change depending on fixture and country