

## Floor Lite

PROJECT:
TYPE:
SOURCE:
NOTES:

### PURELED SPECIFICATIONS

<b>LED Chip</b>	Cree XHP-50-2 Plug and Play field replaceable LED board
<b>Luminaire Output</b>	600 Lumens @ 1050mA (6 watts), 420 Lumens @ 700mA (4 watts), 240 Lumens @ 350mA (2 watts), delivered from luminaire with unobstructed beam.
<b>Lumens Per Watt</b>	100 Lumens @ 6 watts minimum, delivered from luminaire with unobstructed beam
<b>CRI (3000K)</b>	90+
<b>Colour Temperatures</b>	2700K, 3000K, 4000K
<b>Beam Angles</b>	15, 25, 38, 60
<b>Ingress Protection</b>	IP67
<b>Warranty</b>	Electronics = 5 years Body Cop/SS = 10 years
<b>Standards</b>	AS/NZS 61046 cUL 1838, 2108 CSA C22.2 No.250.7, No.250.0-08 CE

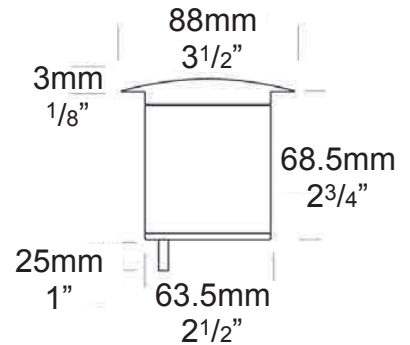

### PRODUCT CONFIGURATION

Please fill in appropriate codes into boxes provided

Cat. No. FLSP/L

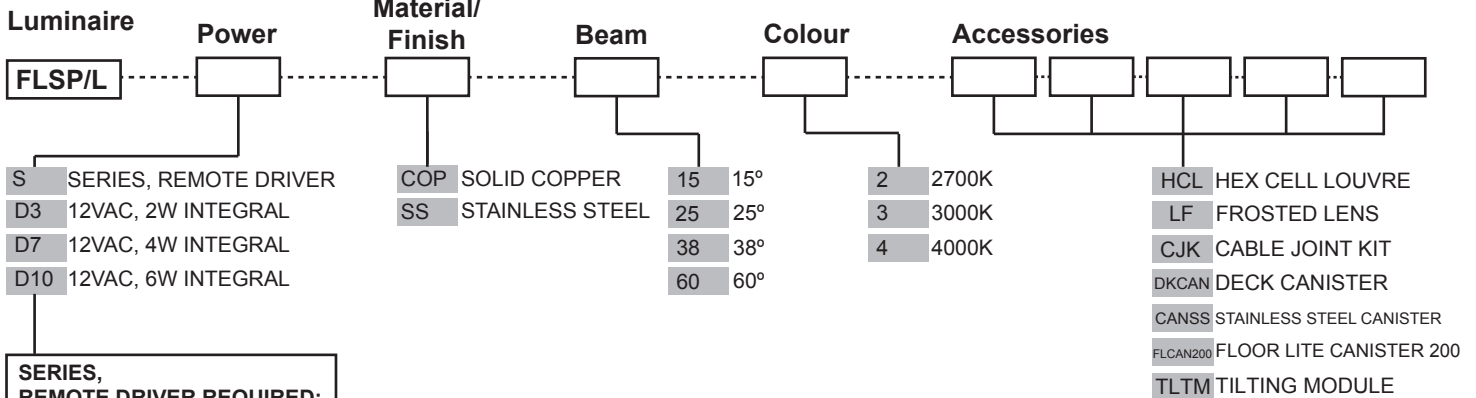

**SERIES, REMOTE DRIVER REQUIRED:**  
Constant current driver  
Individual fixtures require 6vdc @ 1050mA maximum

**12VAC INTEGRAL DRIVER:**  
Hunza integrated plug and play driver (included)  
Input: 9-15VAC.  
Output: 6vdc @ D3=350mA, D7=700mA, D10=1050mA (1050mA limited to ≤ 40°C (104°F) ambient temperature in stainless steel)

**OTHER LAMP OPTIONS:**  
 FLSP/H - MR16 Halogen 12V Lamp  
 FLSP/SL - MR16 LED Retrofit 12V Lamp (lamps vary by market - please refer to supplier for details)  
 FLSP/GUH - GU10 120/240V Halogen Lamp (body length increases for all GU10 lamps)  
 FLSP/GUSL - GU10 LED Retrofit 120/240V Lamp (lamps vary by market - please refer to supplier for details)

[Click here for halogen specification sheet](#)

[Click here for 240v Remote Power Supply Guidance Charts](#)  
[Click here for USA Remote Power Supply Guidance Charts](#)

# LUMINAIRE CONSTRUCTION

CNC machined from one of the following

**metals:**

**Copper**

Body: 63.5mm (2<sup>1/2</sup>" x 10mm (3/8").

End cap: solid copper 63.5mm (2<sup>1/2</sup>" rod.

Flange: solid copper 90mm (3<sup>1/2</sup>").

**316 Stainless Steel**

Body: solid 316 stainless steel 63.5mm (2<sup>1/2</sup>" x 9mm (3/8").

End cap: solid 316 stainless steel 63.5 (2<sup>1/2</sup>" rod.

Flange: 316 stainless steel 90mm (3<sup>1/2</sup>").

**Mounting:**

The luminaire is pushed into the canister and is held by two silicone "O" rings.

CANSS, FLCAN200: cast into

concrete, concrete block, brick, etc.

DKCAN: mounted into wooden decks, wooden frames, etc.

**Luminaire Weight:**

Cop: 1.200kg (2lb 10oz)

SS: 0.995kg (2lb 3oz)

**Lens:**

10mm (3/8") extra clear low iron flush fit shatter resistant glass.

Lifetime warranty.

**Gaskets:**

Silicone, iron impregnated 220°C (428°F)

## ACCESSORIES

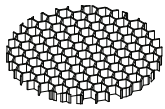

Hex Cell Louvre

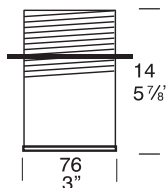

Deck Canister

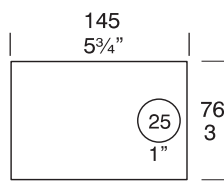

Stainless Steel Canister

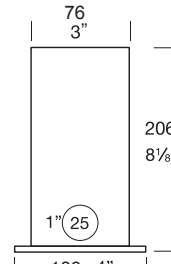

Floor Canister 200

## BEAM ANGLES

High efficiency PMMA TIR lenses. Field replaceable

IES files available for download: [hunzalighting.com/downloads](http://hunzalighting.com/downloads)

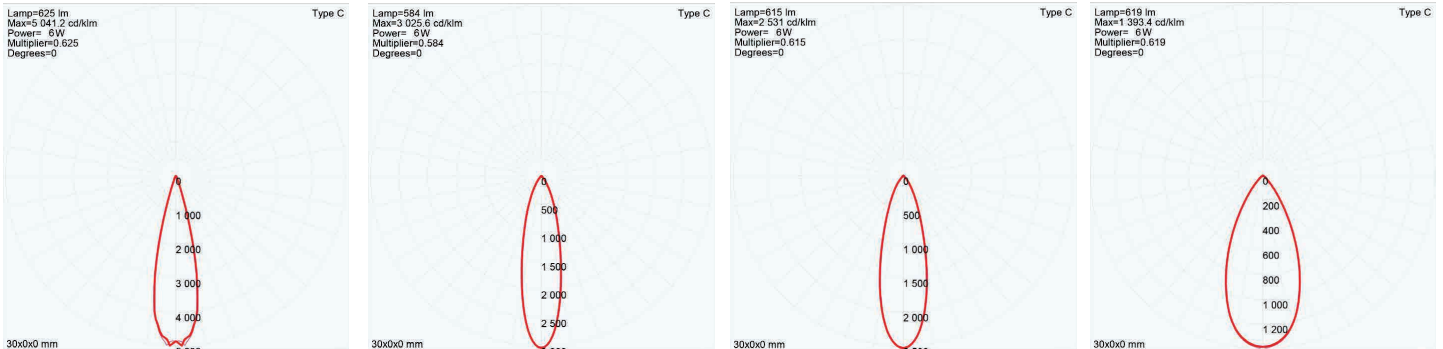

15° FWHM TIR

25° FWHM TIR

38° FWHM TIR

60° FWHM TIR

## WIRING GUIDE

Series/remote driver

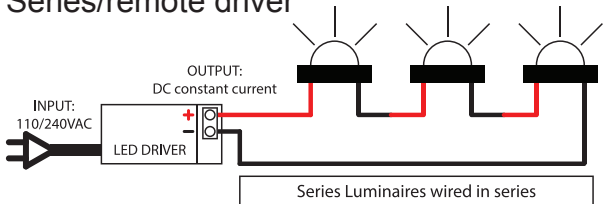

Diagrams are a guide only, wire colours and polarity may change depending on fixture and country

Available for download: [hunzalighting.com/downloads](http://hunzalighting.com/downloads)

12v integral driver

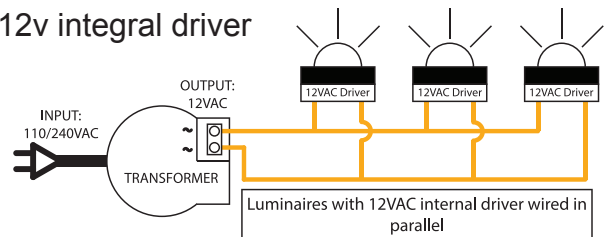

Specifications may change without notification

Aug 2017