

Flush Floor Lite Square

Cat. No. FFLSPSQ
Cat. No. FFLSPSQGU



The Flush Floor Lite Square has been designed to mount flush with the level of a pathway, hotel floor or a building foyer. The 'Flush Fit' lens stops water pooling and depositing dirt on the lens. There is no lip to trip over and the luminaire can be driven over or walked upon without being damaged.

The square shape of the flange makes it ideal for mounting in tiled areas.

A GU10 version of this luminaire is also available for line voltage lamps.

A mounting canister is included for easy installation.

Ordering Information

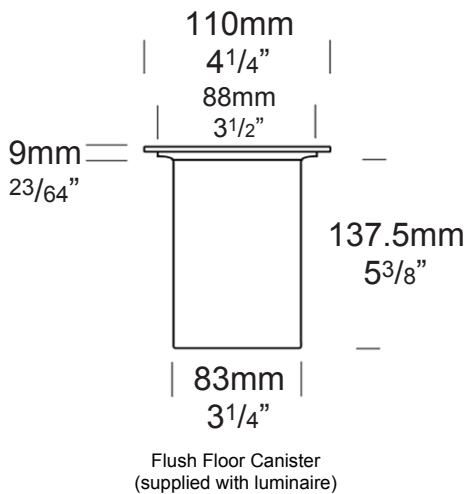

Luminaire Type	Material	Accessories
FFLSPSQ - Flush Floor Lite Square	SS - Stainless Steel	CJK150 - Cable Joint Kit
FFLSPSQGU - Flush Floor Lite Square GU10		HCL - Hex Cell Louvre
		LENSSTEPF - Frosted Lens

Ordering Example: FFLSPSQ SS - Flush Floor Lite Square in Stainless Steel
FFLSPSQGU SS - Flush Floor Lite Square GU10 in Stainless Steel
HCL - Hex Cell Louvre
(accessories ordered separately)

HUNZA™ PURE OUTDOOR LIGHTING

HUNZA FACTORY 130
Felton Mathew Ave
Glen Innes
Auckland 1072
New Zealand

Ph: 64-9-528 9471 Fax: 64-9-528 9361
hunza@hunza.co.nz
www.hunzalighting.com

INTERNATIONAL CONTACTS:
www.hunzalighting.com/contact.php

Specifications may change without notice.
Manufactured in New Zealand.
© 2016 Hunza Holdings Ltd.

Ver 1.4

Luminaire Construction

CNC machined from one of the following materials

316 Stainless Steel

Body: 63.5mm (2½") x 10mm (3/8") stainless steel tube.

End cap: 63.5mm (2½") solid stainless steel rod.

Inner Flange: 90mm (3½") solid stainless steel rod.

Canister Flange: solid stainless steel 110mm (4½") x 110mm (4½").

Canister: PVC canister 137.5 (5½") x 3mm (1/8").

Mounting

The luminaire is pushed into the canister and is held in by a silicone "O" ring. The canister is cast into concrete, brick, tiles, etc.

Maximum driver over speed - 10km/h (6mph).

Maximum vehicle weight - 1500kg (3300lbs).

Features

Lens

10mm (3/8") clear tempered shatter resistant glass.

Gasket

Silicone, iron impregnated 220°C (428°F)

Lamp Holders

MR16 & GU10 - 350°C (662°F) ceramic multi contact lamp holder with 250°C (480°F) Teflon cables.

Accessories

Cable Joint Kit (Cat. CJK150). Not approved for USA/Canada.

Frosted Lens (Cat. LENSSTEPF).

Hex Cell Louvre (Cat. HCL).

Standards

EN60598, IP67, UL1838, 

Luminaire Weight

Copper - 1.700kg (3lb 12oz)

Stainless Steel - 1.500kg (3lb 5oz)

Power Supply

Hunza Inground or Wall Mount

Transformer: not included.

USA and Canada

Hunza Wall Mount Transformer: not included.

Lamp Options

MR16 - 20, 35 or 50 watt lamp max.

GU10 - 10, 25 or 35 watt lamp max.

USA and Canada

MR16 - 20, 35 or 50 watt lamp max.

GU10 - lamp not supplied.

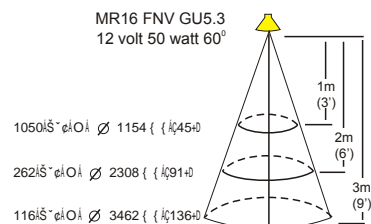
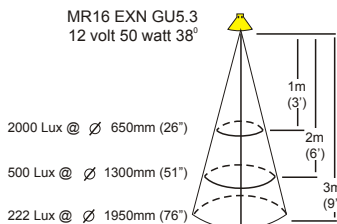
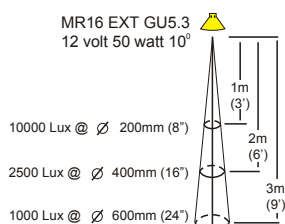
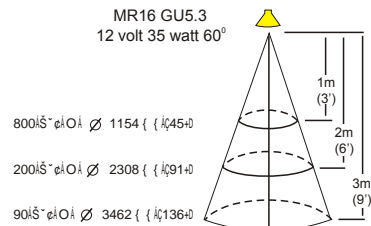
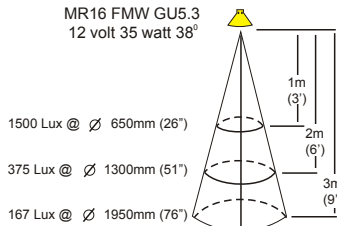
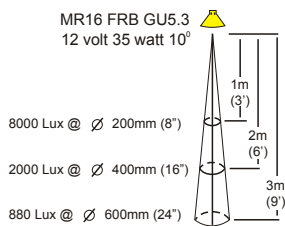
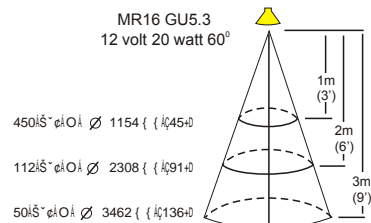
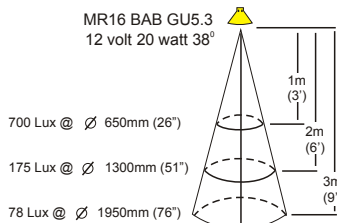
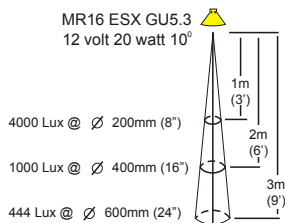

HUNZA™ PURE OUTDOOR LIGHTING

HUNZA FACTORY
130 Felton Mathew
Ave Glen Innes
Auckland 1072
New Zealand

Ph: 64-9-528 9471
Fax: 64-9-528 9361
hunza@hunza.co.nz
www.hunzalighting.com

INTERNATIONAL CONTACTS:
www.hunzalighting.com/contact.php

Specifications may change without notice.
Manufactured in New Zealand.
© 2016 Hunza Holdings Ltd.

Ver 1.4