

Pole Spot

PROJECT:
TYPE:
SOURCE:
NOTES:

PURELED SPECIFICATIONS

LED Chip	Cree XHP-50-2 Plug and Play field replaceable LED board
Luminaire Output	600 Lumens @ 1050mA (6 watts), 420 Lumens @ 700mA (4 watts), 240 Lumens @ 350mA (2 watts), delivered from luminaire with unobstructed beam.
Lumens Per Watt	100 Lumens minimum @ 6 watts, delivered from luminaire with unobstructed beam
CRI (3000K)	90+
Colour Temperatures	2700K, 3000K, 4000K
Beam Angles	15, 25, 38, 60
Ingress Protection	IP56/IP66
Warranty	Electronics = 5 years Body Cop/SS = 10 years Body Aluminium = 5 years
Standards	AS/NZS 61046 cUL 1838, 2108 CSA C22.2 No.250.7, No.250.0-08 CE

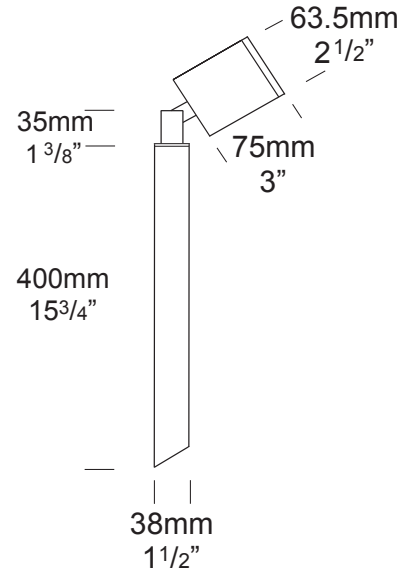

PRODUCT CONFIGURATION

Please fill in appropriate codes into boxes provided

Cat. No. PS/L

Luminaire	Power	Material/ Finish	Beam	Colour	Accessories
<input type="text" value="PS/L"/>	<input type="text"/>	<input type="text"/>	<input type="text"/>	<input type="text"/>	<input type="text"/>
S SERIES, REMOTE DRIVER D3 12VAC, 2W INTEGRAL D7 12VAC, 4W INTEGRAL D10 12VAC, 6W INTEGRAL		ALUMINIUM EBK BLACK EBZ BRONZE EOGR OLIVE GREEN EWH WHITE EWB WHITE BIRCH EDG DARK GREY ESTAR SILVER STAR ECT CORTEN COP SOLID COPPER SS STAINLESS STEEL	15 15° 25 25° 38 38° 60 60°	2 2700K 3 3000K 4 4000K	HCL HEX CELL LOUVRE SNT SNOOT GG GLARE GUARD LF FROSTED LENS FM FLANGE MOUNT LKN LOCKING KNUCKLE CJK CABLE JOINT KIT

SERIES, REMOTE DRIVER REQUIRED:
Constant current driver
Individual fixtures require 6vdc @ 1050mA maximum

12VAC INTEGRAL DRIVER:
Hunza integrated plug and play driver (included)
Input: 9-15VAC, 7watt total
Output: 6vdc @ D3=350mA, D7=700mA, D10=1050mA (1050mA limited to ≤ 40°C (104°F) ambient temperature in stainless steel)

OTHER LAMP OPTIONS:
 PS/H - MR16 Halogen 12V Lamp
 PS/SL - MR16 LED Retrofit 12V Lamp (lamps vary by market - please refer to supplier for details)
 PS/GUH - GU10 120/240V Halogen Lamp (body length increases for all GU10 lamps)
 PS/GUSL - GU10 LED Retrofit 120/240V Lamp (lamps vary by market - please refer to supplier for details)

[Click here for halogen specification sheet](#)

[Click here for 240v Remote Power Supply Guidance Charts](#)

[Click here for USA Remote Power Supply Guidance Charts](#)

LUMINAIRE CONSTRUCTION

CNC machined from one of the following metals:

Aluminium

Body: solid high corrosion resistant 63.5mm (2^{1/2"}) x 10mm (3/8") aluminium.
 End cap: solid aluminium 63.5mm (2^{1/2"}) rod, with chromate substrate and high UV resistant polyester powder coat.
 Pole: solid aluminium 38mm (1^{1/2"}) tube.
 Colours: Black, Bronze, Silver Star, White, White Birch, Olive Green, Dark Grey, Corten.

Copper

Body: 63.5mm (2^{1/2"}) x 10mm (3/8").
 End cap: solid copper 63.5mm (2^{1/2"}) rod.
 Pole: solid copper 38mm (1^{1/2"}) tube.

316 Stainless Steel

Body: 63.5mm (2^{1/2"}) x 10mm (3/8").
 End cap: solid 316 stainless steel 63.5 (2^{1/2"})
 Pole: 316 stainless steel 38mm (1^{1/2"}) tube.

Knuckles:

Aluminium and Copper luminaires - 360° rotation and 90-180° elevation, solid brass with anti rust spring.
 Stainless Steel luminaires - 360° rotation and 90-180° elevation, full stainless steel construction.

Step Lens:

10mm (3/8") Extra clear, low iron, shatter resistant glass.
 Lifetime warranty.

Gaskets:

Silicone, iron impregnated 220°C (428°F)

Mounting

The pole 400mm (15^{3/4"}) is directly mounted into the earth or concrete. Flange Mount option is available for hard surfaces.

Luminaire Weight:

Low voltage
 Alum: 1.00kg (2lb 3oz)
 Cop: 1.70kg (3lb 12oz)
 SS: 1.50kg (3lb 5oz)

ACCESSORIES

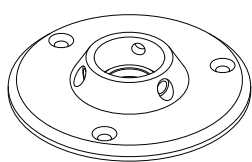

Flange Mount

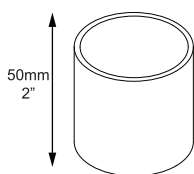

Snoot

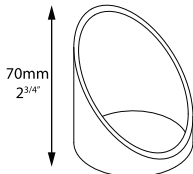

Glare Guard

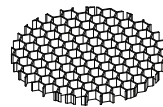

Hex Cell Louvre



Locking Knuckle

BEAM ANGLES

High efficiency PMMA TIR lenses. Field replaceable

IES files available for download: hunzalighting.com/downloads

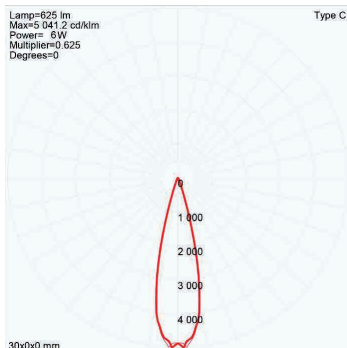

15° FWHM TIR

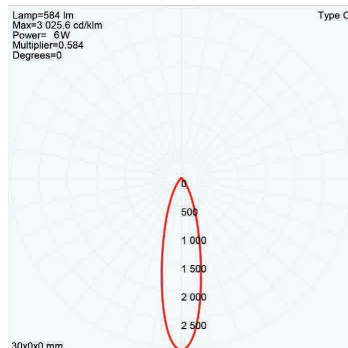

25° FWHM TIR

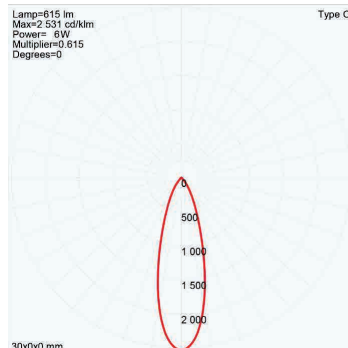

38° FWHM TIR

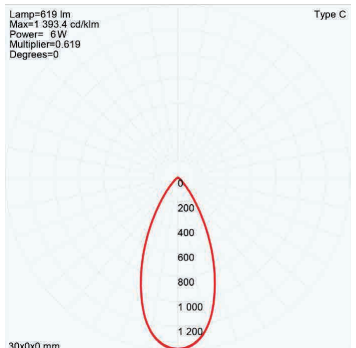

60° FWHM TIR

WIRING GUIDE

Series/remote driver

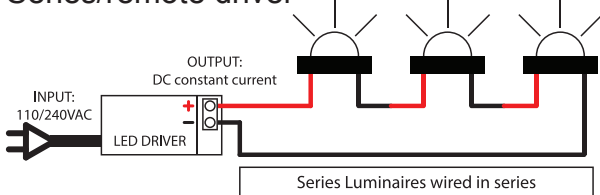

Diagrams are a guide only, wire colours and polarity may change depending on fixture and country

Available for download: hunzalighting.com/downloads

12v integral driver

