

Eave Lite Square

PROJECT:
TYPE:
SOURCE:
NOTES:

PURELED SPECIFICATIONS

LED Chip	Cree XHP-50-2 Plug and Play field replaceable LED board
Luminaire Output	600 Lumens @ 1050mA (6 watts), 420 Lumens @ 700mA (4 watts), 240 Lumens @ 350mA (2 watts), delivered from luminaire with unobstructed beam.
Lumens Per Watt	100 Lumens @ 6 watts minimum, delivered from luminaire with unobstructed beam
CRI (3000K)	90+
Colour Temperatures	2700K, 3000K, 4000K
Beam Angles	15, 25, 38, 60
Ingress Protection	IP66
Warranty	Electronics = 5 years Flange Cop / SS = 10 years Flange Aluminium = 5 years
Standards	AS/NZS 61046 cUL 2108 (Retro - not UL approved) CSA C22.2 No. 250.0-08 CE

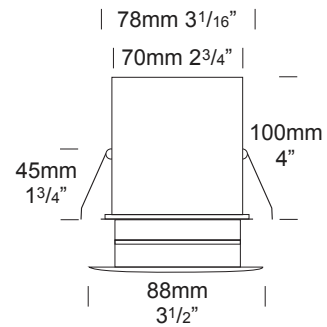

PRODUCT CONFIGURATION

Please fill in appropriate codes into boxes provided

Cat. No. EAVESQ/L

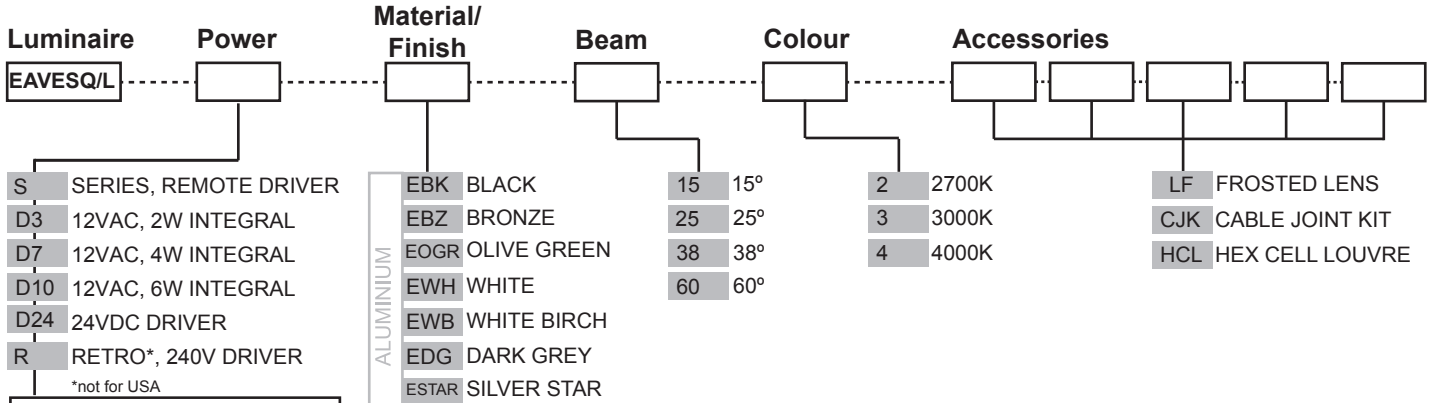

SERIES, REMOTE DRIVER REQUIRED:
Constant current driver
Individual fixtures require 6vdc @ 1050mA maximum

12VAC INTEGRAL DRIVER:
Hunza integrated plug and play driver (included)
Input: 9-15VAC
Output: 6vdc @ D3=350mA, D7=700mA, D10=1050mA (1050mA limited to ≤ 40°C (104°F) ambient temperature in stainless steel)

240VAC RETRO DRIVER:
Input: 240vac, 5 watt total (included)
Output: 6vdc, 700mA (non dimming)

24VDC DRIVER:
Input: 24vdc.
Output: 18vdc @ 700mA constant current (non dimming).
Note: not for USA.

OTHER LAMP OPTIONS:
EAVESQ/H - MR16 Halogen 12V Lamp
EAVESQ/SL - MR16 LED Retrofit 12V Lamp (lamps vary by market - please refer to supplier for details)
EAVESQ/GUH - GU10 120/240V Halogen Lamp
EAVESQ/GUSL - GU10 LED Retrofit 120/240V Lamp (lamps vary by market - please refer to supplier for details)

[Click here for halogen specification sheet](#)

[Click here for 240v Remote Power Supply Guidance Charts](#)
[Click here for USA Remote Power Supply Guidance Charts](#)

LUMINAIRE CONSTRUCTION

CNC machined from one of the following metals:

Aluminium:

Body: solid anodised aluminium.
Flange: high corrosion resistant 88mm x 88mm (3^{1/2}" x 3^{1/2}") solid aluminium rod with chromate substrate and high UV resistant polyester powder coat.

Colours:

Black, Bronze, Silver Star, White, White Birch, Olive Green, Dark Grey, Corten.

Copper:

Flange: 88mm x 88mm (3^{1/2}" x 3^{1/2}") solid copper.

316 Stainless Steel:

Flange: 88mm x 88mm (3^{1/2}" x 3^{1/2}") electro polish 316 stainless steel. This finish increases the protection against corrosion by up to 33%.

Canister: 316 stainless steel.

Lens:

10mm (3/8") extra clear low iron flush fit shatter resistant glass.
Lifetime Warranty.

Gaskets:

Silicone, iron impregnated 220°C (428°F)

Mounting:

Via canister supplied, which maintains the aesthetic look of the flange by eliminating any mounting holes in the flange. The Eave Lite Square canister is designed to fit through a 70mm (2^{3/4}") hole and be fixed into position by two spring clips. The luminaire is held in the canister by an "O" ring.

Luminaire Weight:

Low voltage
Alum: 0.400kg (14oz)
Cop: 1.000kg (2lb 3oz)
SS: 0.950kg (2lb 2oz)
Retro
Alum: 0.600kg (1lb 5oz)
Cop: 1.200kg (2lb 10oz)
SS: 1.150kg (2lb 9oz)

ACCESSORIES

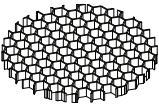

Hex Cell Louvre

BEAM ANGLES

High efficiency PMMA TIR lenses. Field replaceable

IES files available for download: hunzalighting.com/downloads

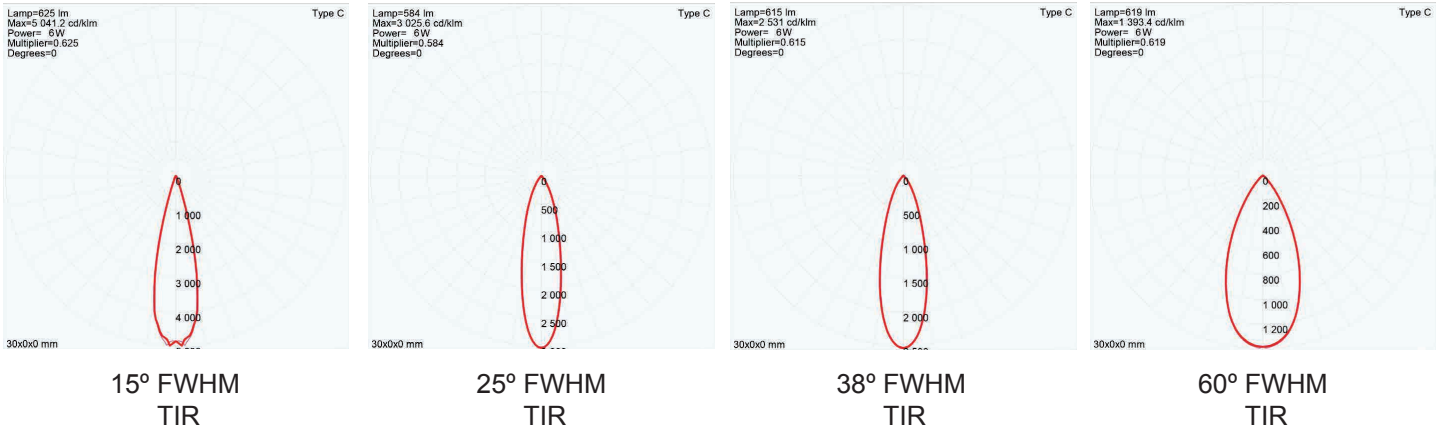

WIRING GUIDE

Available for download: hunzalighting.com/downloads

Series/remote driver

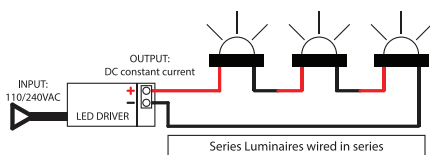

Diagrams are a guide only, wire colours and polarity may change depending on fixture and country

110/240v integral driver

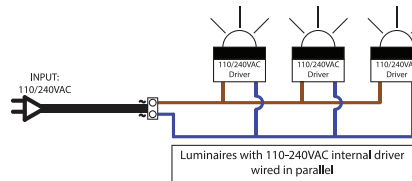

12v integral driver

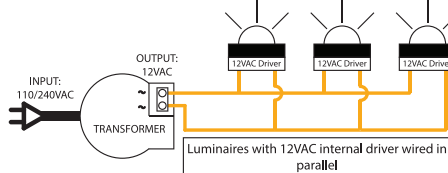

24vdc integral driver

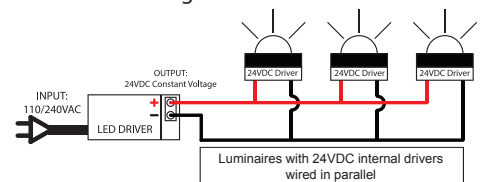

Specifications may change without notification Aug 2017