

Wall Spot

PROJECT: _____

TYPE: _____

SOURCE: _____

NOTES: _____

PURELED SPECIFICATIONS

LED Chip	Cree XHP-50-2 Plug and Play field replaceable LED board
Luminaire Output	600 Lumens @ 1050mA (6 watts), 420 Lumens @ 700mA (4 watts), 240 Lumens @ 350mA (2 watts), delivered from luminaire with unobstructed beam.
Lumens Per Watt	100 Lumens minimum @ 6 watts, delivered from luminaire with unobstructed beam
CRI (3000K)	90+
Colour Temperatures	2700K, 3000K, 4000K
Beam Angles	15, 25, 38, 60
Ingress Protection	IP66
Warranty	Electronics = 5 years Body Cop/ SS = 10 years Body Aluminium = 5 years
Standards	AS/NZS 61046, EN60598 cUL 1838, 2108, 1598 CSA C22.2 No. 250.7, No. 250.0-08, No. 250.0 CE

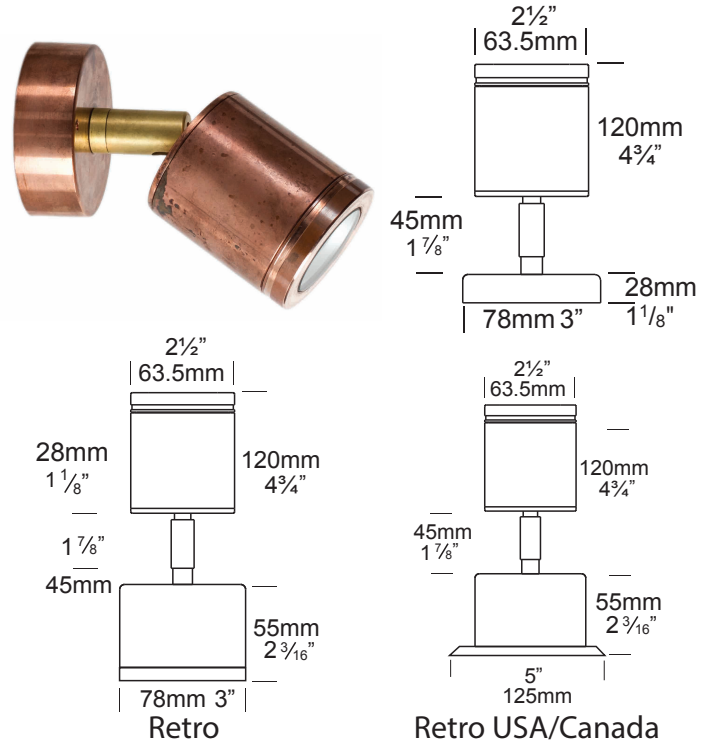

PRODUCT CONFIGURATION

Please fill in appropriate codes into boxes provided

Cat. No. WS/L

Luminaire	Power	Material/Finish	Beam	Colour	Accessories
WS/L					
S 1050mA Input, Series Wired 6W D3 12VAC Input, Parallel Wired 2W D7 12VAC Input, Parallel Wired 4W D10 12VAC Input, Parallel Wired 6W R RETRO, 110/240V Input, Parallel Wired		ALUMINIUM EBK BLACK EBZ BRONZE EOGR OLIVE GREEN EWH WHITE EWB WHITE BIRCH EDG DARK GREY ESTAR SILVER STAR ECT CORTEN COP SOLID COPPER SS STAINLESS STEEL	15 15° 25 25° 38 38° 60 60°	2 2700K 3 3000K 4 4000K	HCL HEX CELL LOUVER SNT SNOOT GG GLARE GUARD LF FROSTED LENS WBAP WALL BOX ADAPTOR LKN LOCKING KNUCKLE CJK CABLE JOINT KIT

SERIES, REMOTE DRIVER REQUIRED:
Constant current driver
Individual fixtures require 6vdc @ 1050mA maximum

12VAC INTEGRAL DRIVER:
Hunza integrated plug and play driver (included)
Input: 9-15VAC
Output: 6vdc @ D3=350mA, D7=700mA, D10=1050mA (1050mA limited to ≤ 40°C (104°F) ambient temperature in stainless steel)

110/240VAC RETRO DRIVER:
Input: 120/240vac, 5 watt total (driver included)
Output: 6vdc, 700mA (non dimming)

OTHER LAMP OPTIONS:
WS/H - MR16 Halogen 12V Lamp
WS/SL - MR16 LED Retrofit 12V Lamp (lamps vary by market - please refer to supplier for details)
WS/GUH - GU10 120/240V Halogen Lamp (body length increases for all GU10 lamps)
WS/GUSL - GU10 LED Retrofit 120/240V Lamp (lamps vary by market - please refer to supplier for details)

[Click here for halogen specification sheet](#)

[Click here for 240v Remote Power Supply Guidance Charts](#)
[Click here for USA Remote Power Supply Guidance Charts](#)

LUMINAIRE CONSTRUCTION

CNC machined from one of the following metals:

Aluminium:

Body: high corrosion resistant 63.5mm (2^{1/2}") x 10mm (3/8") aluminium.

End cap: solid aluminium 63.5mm (2^{1/2}") rod.
Base and Mounting Plate (Retro™): handspun 2mm (5/64") aluminium. Base cast from virgin CC401 low copper aluminium alloy chromate substrate and high UV resistant polyester powder coat.

Colours:

Black, Bronze, Silver Star, White, White Birch, Olive Green, Dark Grey, Corten.

Copper:

Body: 63.5mm (2^{1/2}") x 10mm (3/8").

End cap: solid copper 63.5mm (2^{1/2}") rod.
Base and Mounting Plate (Retro™): handspun 2mm (5/64") copper disk and forged brass.

316 Stainless Steel:

Body: 63.5mm (2^{1/2}") x 10mm (3/8").

End cap: solid 316 stainless steel 63.5 (2^{1/2}") rod.

Base and Mounting Plate (Retro™): investing cast and CNC machined 316 stainless steel.

Step Lens:

10mm (3/8") extra clear, low iron, shatter resistant glass.

Lifetime warranty.

Gaskets:

Silicone, iron impregnated 220°C (428°F).

Knuckles:

Copper luminaires: 360° rotation and 0-90° elevation, solid brass with anti rust spring.

Stainless Steel luminaires: 360° rotation and 0-90° elevation, full stainless steel construction.

Mounting:

12 volt: the luminaire is mounted to the wall using two 316 stainless screws through a shallow base 28mm (1^{1/8}") in depth.

Retro™ (110/240-12volt): a mounting plate is fixed to the wall using two screws and the luminaire is fitted to the mounting plate.

Luminaire Weight:

Low voltage

Alum: 0.495kg (1lb 1oz)

Cop: 1.300kg (2lb 13oz)

SS: 1.080kg (2lb 6oz)

Retro™

Alum: 0.900kg (1lb 15oz)

Cop: 1.710kg (3lb 12oz)

SS: 1.500kg (3lb 4oz)

ACCESSORIES

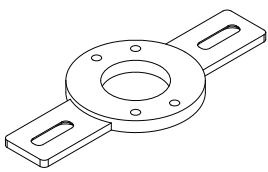

Wall Box Adaptor

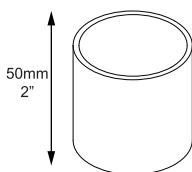

Snoot

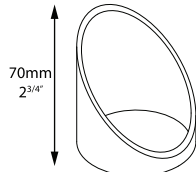

Glare Guard

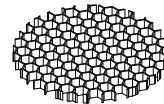

Hex Cell Louvre

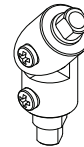

Locking Knuckle

BEAM ANGLES

High efficiency PMMA TIR lenses. Field replaceable

IES files available for download: hunzalighting.com/downloads

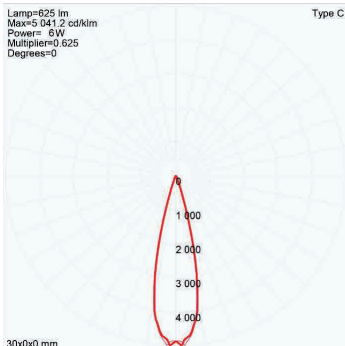

15° FWHM TIR

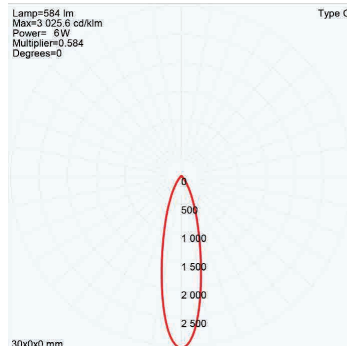

25° FWHM TIR

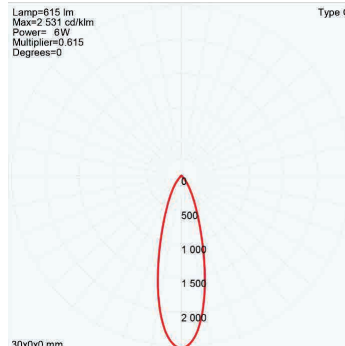

38° FWHM TIR

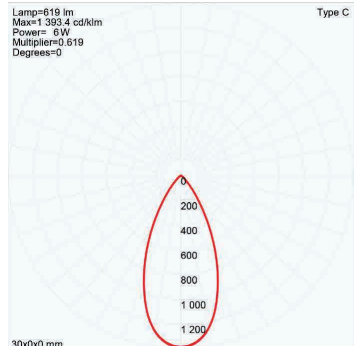

60° FWHM TIR

WIRING GUIDE

Series/remote driver

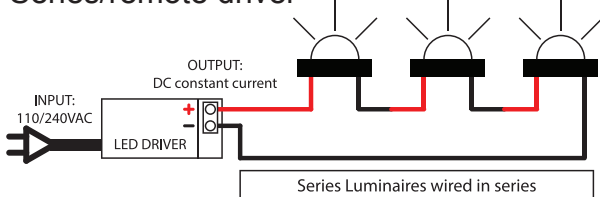

Series Luminaires wired in series

12v integral driver

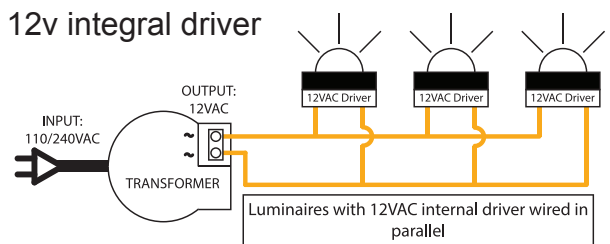

Luminaires with 12VAC internal driver wired in parallel

Diagrams are a guide only, wire colours and polarity may change depending on fixture and country

Available for download: hunzalighting.com/downloads