

## Spike Spot High Power / Retro PURE LED

PROJECT:
TYPE:
SOURCE:
NOTES:

### SPECIFICATIONS



<b>LED Chip</b>	Cree CXA1512 Plug and Play field replaceable LED board
<b>Luminaire Output</b>	1200 Lumens @ 700mA delivered from luminaire with unobstructed beam.
<b>Lumens Per Watt</b>	100 Lumens minimum @ 12 watts, delivered from luminaire with unobstructed beam
<b>CRI (3000K)</b>	85+ Standard, 90+ Optional
<b>Colour Temperatures</b>	2700K, 3000K, 4000K
<b>Beam Angles</b>	15, 30, 40, 70
<b>Ingress Protection</b>	IP66

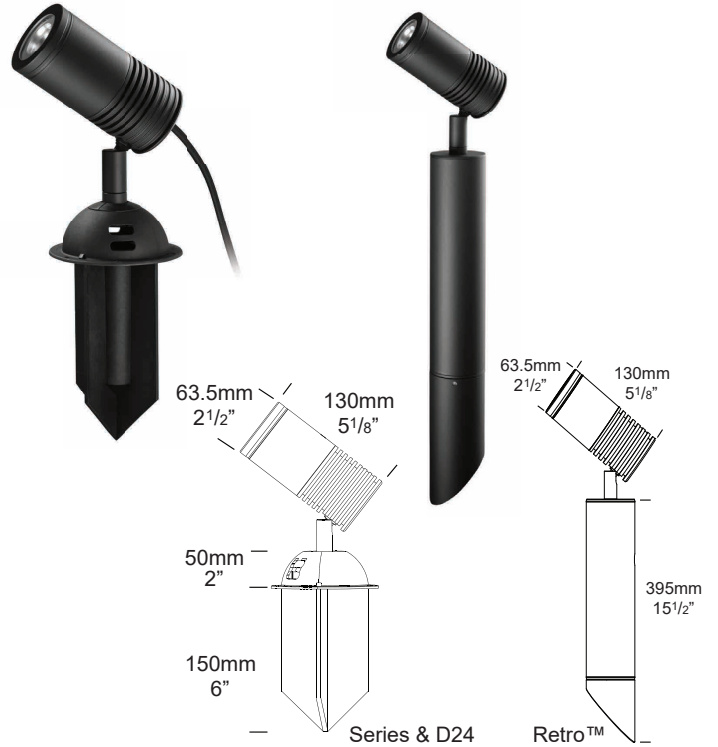

<b>Warranty</b>	Electronics = 5 years Body Aluminium = 5 years
<b>Standards</b>	AS/NZS 61046 cUL 2108, 1598 CSA C22.2 No. 250.0-08, No. 250.0 CE

### PRODUCT CONFIGURATION

Please fill in appropriate codes into boxes provided

Cat. No. SS/HP

Luminaire	Power	Material/Finish	Beam	Colour	Accessories
SS/HP					
SR 700mA Input, Series Wired 12W		ALUMINIUM	15 15°	2 2700K	LKN LOCKING KNUCKLE
R 110/240V Input, Retro, Parallel Wired		EBK BLACK	30 30°	3 3000K	HCL HEX CELL LOUVRE KIT
D24 24VDC Input, Parallel Wired		EOGR OLIVE GREEN	40 40°	4 4000K	SNT SNOOT
		EWH WHITE	70 70°	39 3000K, 90+ CRI	GG GLARE GUARD
		EWB WHITE BIRCH			LF FROSTED LENS
		EDG DARK GREY			CJK CABLE JOINT KIT
		ESTAR SILVER STAR			FM FLANGE MOUNT (Retro version only)
		ECT CORTEN			FM90 EXTERNAL 90MM FLANGE MOUNT (Retro version only)

**SERIES REMOTE DRIVER:**  
Constant current driver (included) individual fixtures require 18vdc @ 700mA maximum. 0-10 volt dimming.

**RETRO 110/240VAC DRIVER:**  
Constant current driver (included).  
Input: 90/305vac, 13 watt total.  
Output: 18vdc, 700mA  
0-10 volt dimming.

**24VDC DRIVER:**  
Input: 24vdc.  
Output: 18vdc @ 700mA constant current (non dimming).  
*Note: not for USA.*

ADDITIONAL COMMENTS:

# LUMINAIRE CONSTRUCTION

**CNC machined from one of the following metals:**

**Aluminium:**

Body: high corrosion resistant 63.5mm (2<sup>1/2</sup>" x 10mm (3/8") aluminium.

Driver Housing (Retro™): solid aluminium 63.5mm (2<sup>1/2</sup>" x 3.25mm (1/8") tube with chromate substrate and high UV resistant polyester "E" powder coat.

**Colours:**

Black, Bronze, Silver Star, White, White Birch, Olive Green, Dark Grey, Corten.

**Knuckles:**

Aluminium luminaires: 360° rotation and 0-90° elevation, solid brass with anti rust spring.

**Cable:**

Water resistant rubber with HUNZA™ Anti-Syphon™ barrier system.

**Lens:**

10mm (3/8") Extra clear, low iron, shatter resistant glass.

Lifetime warranty

**Gaskets:**

Silicone, iron impregnated 220°C (428°F)

**Mounting:**

Series: Ground spike 150mm (6") inserted directly into the earth.

Retro™ (110/240-12volt): driver housing pole 395mm (15<sup>1/2</sup>") is directly mounted into the earth.

Flange Mount option is available for hard surfaces.

**Luminaire Weight:**

Low voltage:

Alum: 0.870 (1lb 15oz)

Retro™

Alum: 1.500 (3lb 5oz)

## ACCESSORIES

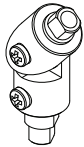

Locking Knuckle

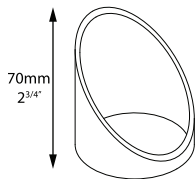

Glare Guard

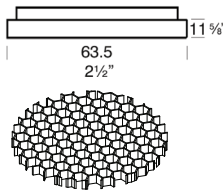

Hex Cell Louvre Kit

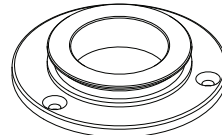

External Flange Mount

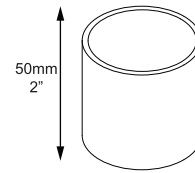

Snoot

## BEAM ANGLES

High efficiency PMMA TIR lenses. Field replaceable

IES files available for download: [hunzalighting.com/downloads](http://hunzalighting.com/downloads)

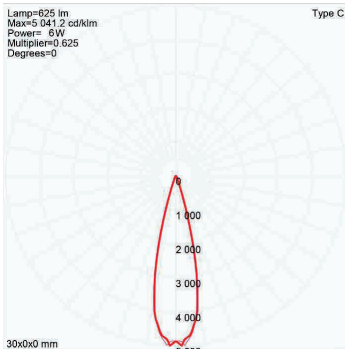

15° FWHM TIR

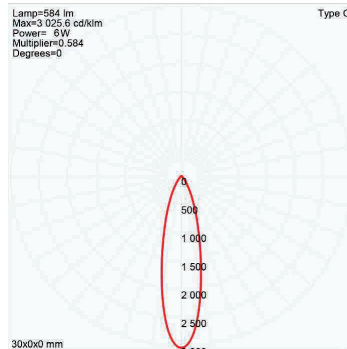

30° FWHM TIR

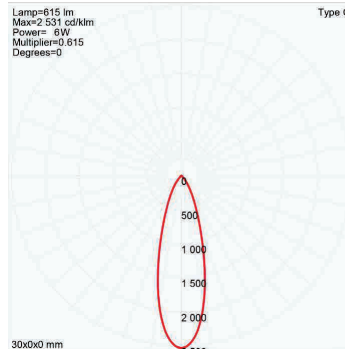

40° FWHM TIR

## WIRING GUIDE

Available for download: [hunzalighting.com/downloads](http://hunzalighting.com/downloads)

Series/remote driver

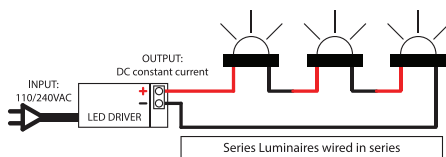

Diagrams are a guide only, wire colours and polarity may change depending on fixture and country

110/240v integral driver

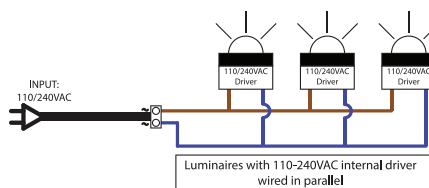

24vdc integral driver

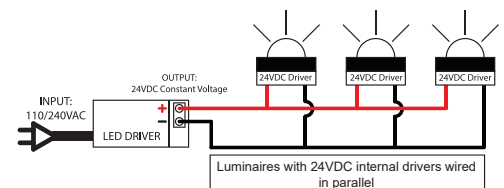

Specifications may change without notification Sept 2021 V2