

Twin Bar Lite

Cat. No. TBL
Cat. No. TBLGU



The Twin Bar Lite is ideal for wall or sign illumination using two 20 watt lamps with an IG40 transformer. The luminaire has two individual spot lites which can be aimed in two entirely different directions. Each lite has a fully adjustable arm allowing 360 degree rotation and 0-90 degree elevation adjustment. The heads are not mounted on a 250mm (10") bar with twin ground spikes.

This luminaire is machined from a choice of solid aluminium with a UV stable powder coat finish, solid copper or 316 stainless steel with a clear, tempered, flush fit, glass lens and high temperature silicone gaskets.

A GU10 version of this luminaire is also available for line voltage lamps. However, longer luminaire bodies are needed to accommodate the longer lamps.

Ordering Information

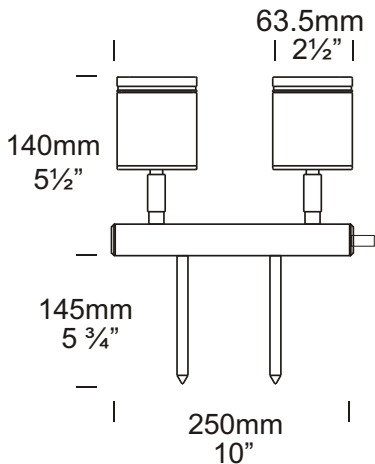

Luminaire Type

TBL - Twin Bar Lite
TBLGU - Twin Bar Lite GU10

Material/Finish

BK - Black
BZ - Bronze
CT - Corten
DG - Dark Grey
OG - Olive Green
STAR - Silver Star
WB - White Birch
WH - White
COP - Copper
SS - Stainless Steel

Accessories

CJK150 - Cable Joint Kit
GG - Glare Guard
HCL - Hex Cell Louvre
LENSSTEPF - Frosted Lens
/300 - Ground Spike
300mm (12")

Ordering example: TBL BK - Twin Bar Lite in Black
TBLGU COP - Twin Bar Lite GU10 in Copper
LENSSTEPF - Frosted Lens
(accessories ordered separately)

HUNZA™ PURE
OUTDOOR
LIGHTING

HUNZA FACTORY
130 Felton Mathew Ave
Glen Innes
Auckland 1072
New Zealand

Ph: 64-9-528 9471
Fax: 64-9-528 9361
hunza@hunza.co.nz
www.hunzalighting.com

INTERNATIONAL CONTACTS:
[http://www.hunzalighting.com/
contact.php](http://www.hunzalighting.com/contact.php)
Specification may change without notice.
Manufactured in New Zealand.
© 2016 Hunza Holdings Ltd.

Luminaire Construction

CNC machined from one of the following metals:

Aluminium

High corrosion resistant aluminium with chromate substrate and high UV resistant powder coat.

Body: 63.5mm (2½") x 10mm (3/8") tube.

End cap: solid aluminium 63.5mm (2½") rod.

Spike: 150mm (6") x 11mm (1/2") aluminium rod.

Colours:

Black, Bronze, Corten, Dark Grey, Olive Green, Silver Star, White Birch, White.

Copper

Body: 63.5mm (2½") x 10mm (3/8") tube.

End cap: solid copper 63.5mm (2½") rod.

Spike: 150mm (6") x 11mm (1/2") copper rod.

316 Stainless Steel

Body: 63.5mm (2½") x 10mm (3/8") tube.

End cap: solid stainless steel 63.5mm (2½") rod.

Spike: 150mm (6") x 11mm (1/2") stainless steel rod.

Mounting

Ground spike 150mm (6") or 300mm (12") directly into the earth.

Features

Lens

10mm (3/8") clear flush fit shatter resistant glass.

Lifetime Warranty.

Gasket

Silicone, iron impregnated 220°C (428°F).

Lamp Holder

MR16 & GU10 - 350°C (662°F) ceramic multi contact lamp holder with 250°C (480°F) Teflon cables.

Accessories

Cable Joint Kit (Cat CJK150). Not approved for USA/Canada.

Glare Guard (Cat. GG).

Hex Cell Louvre (Cat. HCL).

Frosted Lens (Cat. LENSSTEPF).

300mm (12") Spike (Cat. /300).

Swivel

Aluminium and Copper luminaires - 360° rotation and 0 - 90° elevation, solid brass with anti rust spring.

Stainless Steel luminaires - 360° rotation and 0 - 90° elevation, full stainless steel construction.

Standards

IP66, UL1838, 

Luminaire Weight

Aluminium - 1.060kg (2lb 5oz)

Copper - 2.840kg (6lb 4oz)

Stainless Steel - 2.420kg (5lb 5oz)

Power Supply

Hunza Inground or Wall Mount Transformer: not included.

USA and Canada

Hunza Wall Mount Transformer: not included.

Lamp Options

MR16 - 20 or 35 watt lamp max.

GU10 - 25 or 35 watt lamp max.

USA and Canada

MR16 - 20 watt lamp max.

GU10 - lamp not supplied.

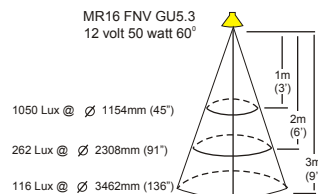
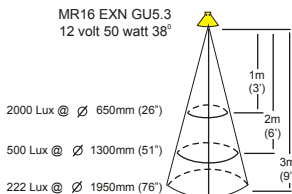
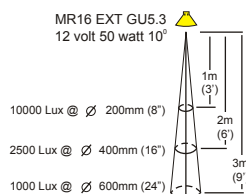
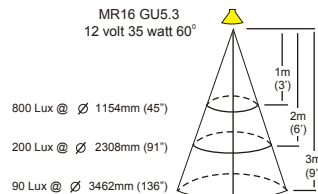
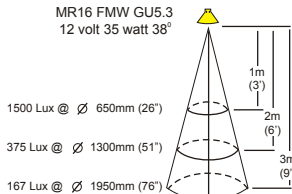
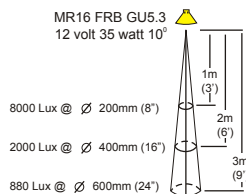
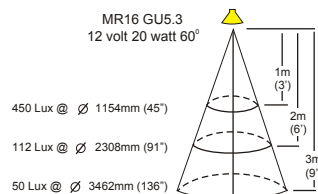
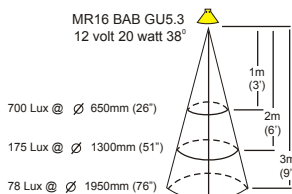
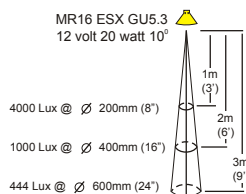

HUNZA™ PURE OUTDOOR LIGHTING

HUNZA FACTORY
130 Felton Mathew Ave
Glen Innes
Auckland 1072
New Zealand

Ph: 64-9-528 9471
Fax: 64-9-528 9361
hunza@hunza.co.nz
www.hunzalighting.com

INTERNATIONAL CONTACTS:
<http://www.hunzalighting.com/contact.php>
Specification may change without notice.
Manufactured in New Zealand.
© 2016 Hunza Holdings Ltd.