

## Spot ULTRA 35

PROJECT:
TYPE:
SOURCE:
NOTES:

### SPECIFICATIONS



<b>LED Chip</b>	Cree CXA 1830 field replaceable LED board
<b>Luminaire Output</b>	2700 Lumens @ 700mA (26 watts) , Delivered from Luminaire with unobstructed beam.
<b>Lumens Per Watt</b>	100 Lumens minimum @ 26 watts, Delivered from Luminaire with unobstructed beam
<b>CRI (3000K)</b>	80 Standard, 90+ Optional
<b>Colour Temperatures</b>	2700K, 3000K, 4000K
<b>Beam Angles</b>	13, 20, 25, 34
<b>Ingress Protection</b>	IP66
<b>Warranty</b>	Electronics = 5 years Body Aluminium = 5 years
<b>Standards</b>	BS/EN 60598.2.2 cUL 2108 CE

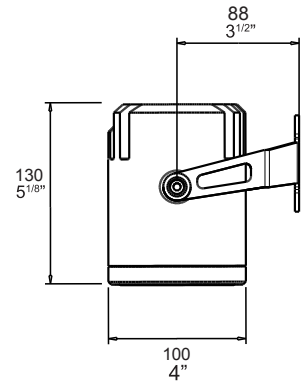

### PRODUCT CONFIGURATION

Please fill in appropriate codes into boxes provided

Cat. No. S/U35

Luminaire	Power	Material/ Finish	Beam	Colour	Accessories
<input type="text" value="S/U35"/>	<input type="text"/>	<input type="text"/>	<input type="text"/>	<input type="text"/>	<input type="text"/>
<b>SR</b> SERIES REMOTE <b>D24</b> 24VDC DRIVER, REMOTE		<b>ALUMINIUM</b> <b>EBK</b> BLACK <b>EBZ</b> BRONZE <b>EOGR</b> OLIVE GREEN <b>EWH</b> WHITE <b>EWB</b> WHITE BIRCH <b>EDG</b> DARK GREY <b>ESTAR</b> SILVER STAR <b>ECT</b> CORTEN	<b>13</b> 13° <b>20</b> 20° <b>25</b> 25° <b>34</b> 34°	<b>2</b> 2700K <b>3</b> 3000K <b>4</b> 4000K <b>39</b> 3000K, 90+ CRI	<b>ULT35HC</b> HEX CELL LOUVRE <b>ULT35SNT</b> SNOOT <b>ULT35GG</b> GLARE GUARD <b>SPK</b> ULTRA 35 SPIKE <b>CJK</b> CABLE JOINT KIT <b>PB/U</b> ULTRA POLE BRACKET

**SERIES REMOTE:**  
Constant current driver (included) individual fixtures require 37vdc @ 700mA maximum. 0-10 volt dimming.

**24VDC DRIVER:**  
Input: 24vdc.  
Output: 36vdc @ 700mA constant current (non dimming).  
*Note: not for USA.*

ADDITIONAL COMMENTS:

# LUMINAIRE CONSTRUCTION

## CNC machined from one of the following metals:

Body - solid high corrosion resistant 101mm (4") aluminium rod.  
 Base - high corrosion resistant 101mm (4") aluminium Rod.  
 Finished with chromate substrate, Epoxy layer and a UV resistant polyester powder coat colour.  
 Fixings and Mechanism - made from 316 Stainless Steel

## Colours:

Black, Bronze, Silver Star, White, Birch, Olive Green, Dark Grey, Corten.

## Step Lens:

12mm (1/2") Extra clear, low iron, shatter resistant glass.  
 Lifetime warranty

## Gaskets:

Silicone, iron impregnated 220°C (428°F)

## Cable:

Water resistant rubber

## Adjustability:

The fully adjustable head allows 360 degrees rotation and 0-120 degrees elevation and can then be fixed in place using the inbuilt locking mechanism.

## Mounting:

The mounting plate is fixed to the surface using three stainless screws. The luminaire is then fixed to the mounting plate

## Luminaire Weight:

4kg (9 lbs)

# ACCESSORIES

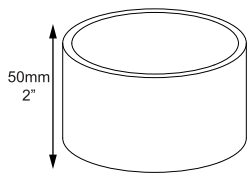

Snoot

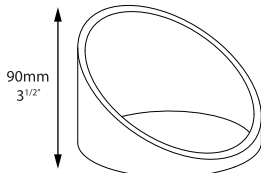

Glare Guard

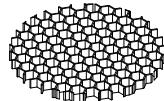

Hex Cell Louvre

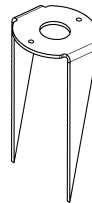

Ultra 35 Spike

# BEAM ANGLES

High efficiency Reflectors. Field replaceable

IES files available for download: [hunzalighting.com/downloads](http://hunzalighting.com/downloads)

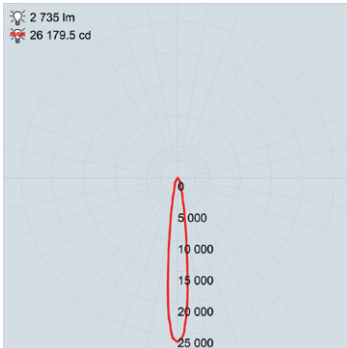

13° FWHM REFLECTOR

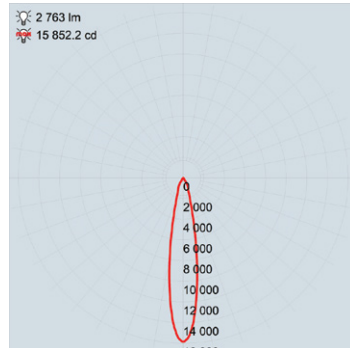

20° FWHM REFLECTOR

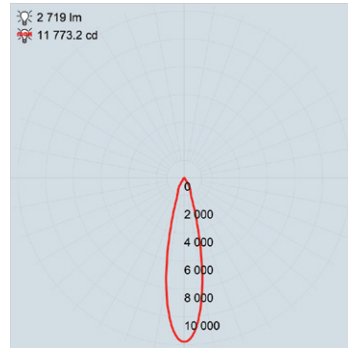

25° FWHM REFLECTOR

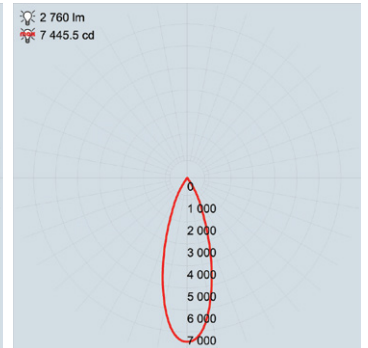

34° FWHM REFLECTOR

# WIRING GUIDE

## Series/remote driver

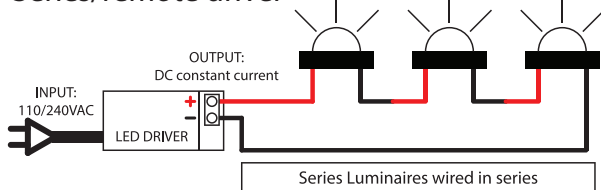

Diagrams are a guide only, wire colours and polarity may change depending on fixture and country

Available for download: [hunzalighting.com/downloads](http://hunzalighting.com/downloads)

## 24vdc integral driver

