

## Bollard round ARCH

PROJECT:

TYPE:

SOURCE:

NOTES:

### SPECIFICATIONS



|                            |   |
|----------------------------|---|
| <b>LED Chip</b>            | Cree CXA 1830 field replaceable LED board                                       |
| <b>Luminaire Output</b>    | 3000 Lumens @ 700mA (26watts), delivered from luminaire with unobstructed beam. |
| <b>Lumens Per Watt</b>     | 100 Lumens minimum @ 26 watts, delivered from luminaire with unobstructed beam  |
| <b>CRI (3000K)</b>         | 80+ Standard, 90+ Optional  |
| <b>Colour Temperatures</b> | 2700K, 3000K, 4000K   |
| <b>Beam Angles</b>         | TYPE 2, TYPE 4 asymmetric   |
| <b>Ingress Protection</b>  | IP66  |
| <b>Warranty</b>            | Electronics = 5 years<br>Body Aluminium = 5 years                               |
| <b>Standards</b>           | BS/EN 60598.2.2<br>cUL 1598<br>CE   |

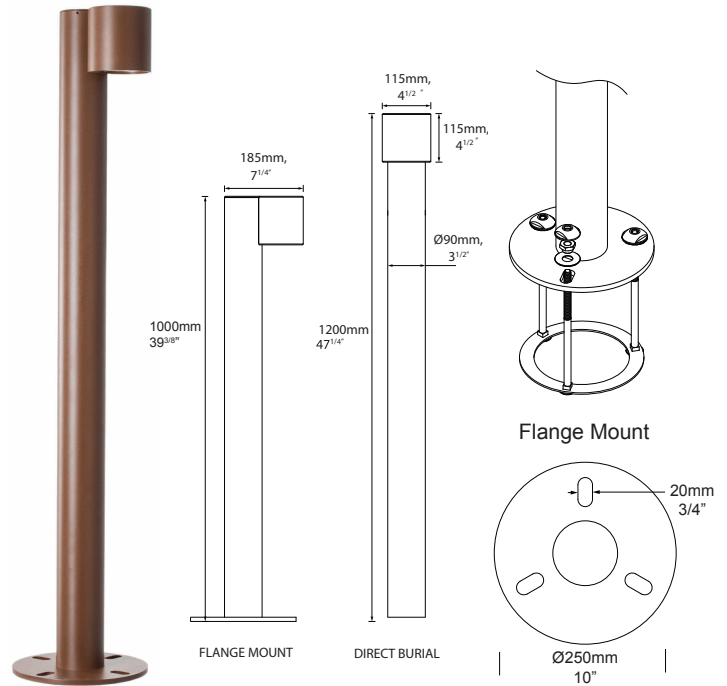

### PRODUCT CONFIGURATION

Please fill in appropriate codes into boxes provided

Cat. No. ARCR

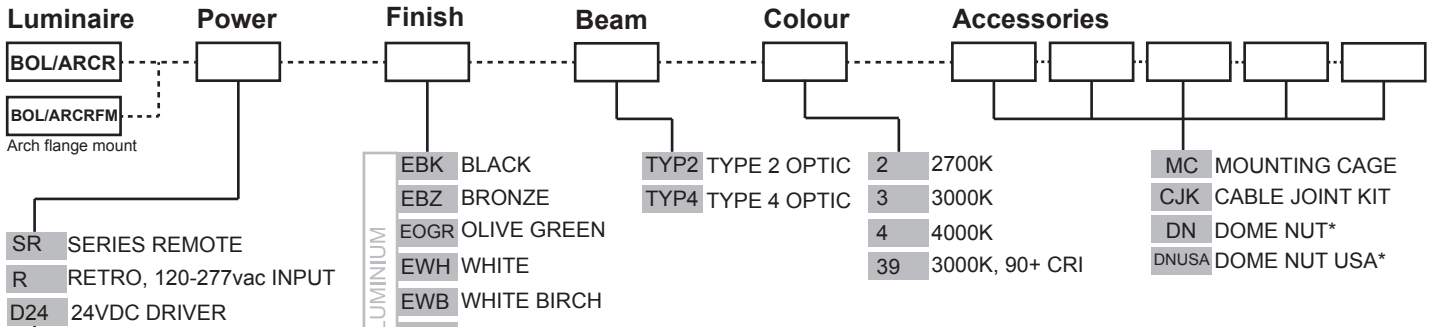

**SERIES REMOTE:** Constant current driver (included) Fixture require 37vdc @ 700mA maximum

**RETRO**  
**110-277vac DRIVER:** Constant current driver (included)  
 Input: 120,240,277 volts Output: 60 watts total 37vdc @ 700mA  
 0-10 volt dimming

**24VDC DRIVER:**  
 Input: 24vdc  
 Output: 36vdc @ 700mA constant current

\*Only available for Flange Mount version

ADDITIONAL COMMENTS:

# LUMINAIRE CONSTRUCTION

**CNC machined from one of the following metals:**

**Aluminium**

Body: High corrosion resistant 115mm (4<sup>1/2</sup>" ) aluminium rod.  
 Tube: high corrosion resistant 90mm (3<sup>1/2</sup>" ) x 3.18mm (1/8" ) aluminium tube.  
 Finished with chromate substrate, Epoxy layer and a UV resistant polyester powder coat colour.  
 Fixings and Mechanism - made from 316 stainless steel.

Colours:

Black, Bronze, Silver Star, White, White Birch, Olive Green, Dark Grey, Corten.

**Step Lens:**

Extra clear optical silicone TIR.

**Gaskets:**

Silicone, iron impregnated 220°C (428°F)

**Cable:**

Water resistant rubber

**Mounting:**

Pole is set directly into concrete.  
 For flange mounting please refer to the Hunza website for mounting instructions.  
 Dome Nut - for use with M12 J-bolts.  
 Dome Nut USA - for use with 1/2" UNC 13 TPI J-bolts.

**Luminaire Weight:**

6kg (13lbs 4oz) without flange

## ACCESSORIES

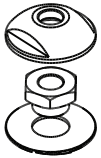

**Dome Nut**

(for use with M12 J-bolts or 1/2" UNC 13 TPI J-bolts)

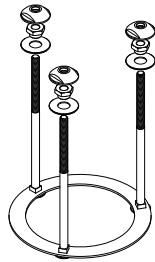

**Mounting cage**

## BEAM ANGLES

High efficiency Reflectors. Feild replaceable

IES files available for download: [hunzalighting.com/downloads](http://hunzalighting.com/downloads)

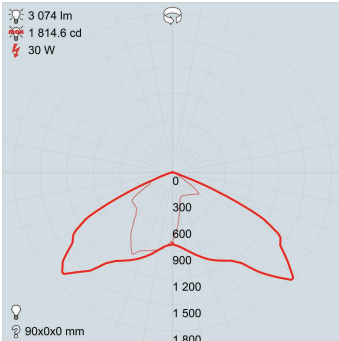

**TYPE 2 OPTIC**

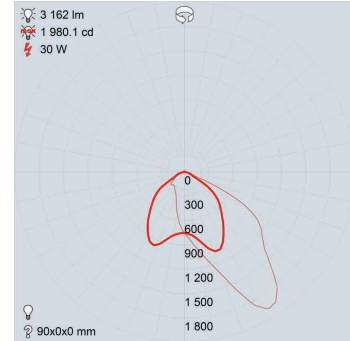

**TYPE 4 OPTIC**

## WIRING GUIDE

Available for download: [hunzalighting.com/downloads](http://hunzalighting.com/downloads)

**Series/remote driver**

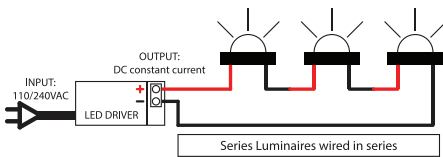

Diagrams are a guide only, wire colours and polarity may change depending on fixture and country

**110/240v integral driver**

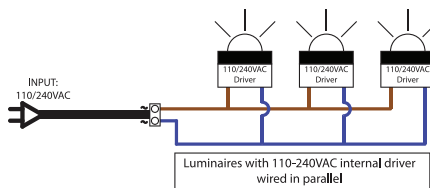

**24vdc integral driver**

