

## Pole Spot

PROJECT:
TYPE:
SOURCE:
NOTES:

### PURELED SPECIFICATIONS

<b>LED Chip</b>	Cree XHP-50-2 Plug and Play field replaceable LED board
<b>Luminaire Output</b>	600 Lumens @ 1050mA (6 watts), 420 Lumens @ 700mA (4 watts), 240 Lumens @ 350mA (2 watts), delivered from luminaire with unobstructed beam.
<b>Lumens Per Watt</b>	100 Lumens minimum @ 6 watts, delivered from luminaire with unobstructed beam
<b>CRI (3000K)</b>	90+
<b>Colour Temperatures</b>	2700K, 3000K, 4000K
<b>Beam Angles</b>	15, 25, 38, 60
<b>Ingress Protection</b>	IP56/IP66
<b>Warranty</b>	Electronics = 5 years Body Cop/SS = 10 years Body Aluminium = 5 years
<b>Standards</b>	AS/NZS 61046 cUL 1838, 2108 CSA C22.2 No.250.7, No.250.0-08 CE

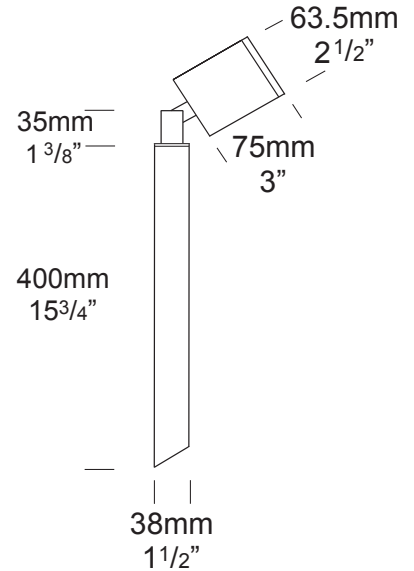

### PRODUCT CONFIGURATION

Please fill in appropriate codes into boxes provided

Cat. No. PS/L

Luminaire	Power	Material/ Finish	Beam	Colour	Accessories
<input type="text" value="PS/L"/>	<input type="text"/>	<input type="text"/>	<input type="text"/>	<input type="text"/>	<input type="text"/>
<b>S</b> SERIES, REMOTE DRIVER <b>D3</b> 12VAC, 2W INTEGRAL <b>D7</b> 12VAC, 4W INTEGRAL <b>D10</b> 12VAC, 6W INTEGRAL		<b>ALUMINIUM</b> <b>EBK</b> BLACK <b>EBZ</b> BRONZE <b>EOGR</b> OLIVE GREEN <b>EWH</b> WHITE <b>EWB</b> WHITE BIRCH <b>EDG</b> DARK GREY <b>ESTAR</b> SILVER STAR <b>ECT</b> CORTEN <b>COP</b> SOLID COPPER <b>SS</b> STAINLESS STEEL	<b>15</b> 15° <b>25</b> 25° <b>38</b> 38° <b>60</b> 60°	<b>2</b> 2700K <b>3</b> 3000K <b>4</b> 4000K	<b>HCL</b> HEX CELL LOUVRE <b>SNT</b> SNOOT <b>GG</b> GLARE GUARD <b>LF</b> FROSTED LENS <b>FM</b> FLANGE MOUNT <b>LKN</b> LOCKING KNUCKLE <b>CJK</b> CABLE JOINT KIT

**SERIES, REMOTE DRIVER REQUIRED:**  
Constant current driver  
Individual fixtures require 6vdc @ 1050mA maximum

**12VAC INTEGRAL DRIVER:**  
Hunza integrated plug and play driver (included)  
Input: 9-15VAC, 7watt total  
Output: 6vdc @ D3=350mA, D7=700mA, D10=1050mA (1050mA limited to ≤ 40°C (104°F) ambient temperature in stainless steel)

**OTHER LAMP OPTIONS:**  
 PS/H - MR16 Halogen 12V Lamp  
 PS/SL - MR16 LED Retrofit 12V Lamp (lamps vary by market - please refer to supplier for details)  
 PS/GUH - GU10 120/240V Halogen Lamp (body length increases for all GU10 lamps)  
 PS/GUSL - GU10 LED Retrofit 120/240V Lamp (lamps vary by market - please refer to supplier for details)

[Click here for halogen specification sheet](#)

[Click here for Remote Power Supply Guidance Charts](#)

# LUMINAIRE CONSTRUCTION

**CNC machined from one of the following metals:**

**Aluminium**

Body: solid high corrosion resistant 63.5mm (2<sup>1/2"</sup>) x 10mm (3/8") aluminium.  
 End cap: solid aluminium 63.5mm (2<sup>1/2"</sup>) rod, with chromate substrate and high UV resistant polyester powder coat.  
 Pole: solid aluminium 38mm (1<sup>1/2"</sup>) tube.  
 Colours:  
 Black, Bronze, Silver Star, White, White Birch, Olive Green, Dark Grey, Corten.

**Copper**

Body: 63.5mm (2<sup>1/2"</sup>) x 10mm (3/8").  
 End cap: solid copper 63.5mm (2<sup>1/2"</sup>) rod.  
 Pole: solid copper 38mm (1<sup>1/2"</sup>) tube.

**316 Stainless Steel**

Body: 63.5mm (2<sup>1/2"</sup>) x 10mm (3/8").  
 End cap: solid 316 stainless steel 63.5 (2<sup>1/2"</sup>)  
 Pole: 316 stainless steel 38mm (1<sup>1/2"</sup>) tube.

**Knuckles:**

Aluminium and Copper luminaires - 360° rotation and 90-180° elevation, solid brass with anti rust spring.  
 Stainless Steel luminaires - 360° rotation and 90-180° elevation, full stainless steel construction.

**Step Lens:**

10mm (3/8") Extra clear, low iron, shatter resistant glass.  
 Lifetime warranty.

**Gaskets:**

Silicone, iron impregnated 220°C (428°F)

**Mounting**

The pole 400mm (15<sup>3/4"</sup>) is directly mounted into the earth or concrete. Flange Mount option is available for hard surfaces.

**Luminaire Weight:**

Low voltage  
 Alum: 1.00kg (2lb 3oz)  
 Cop: 1.70kg (3lb 12oz)  
 SS: 1.50kg (3lb 5oz)

## ACCESSORIES

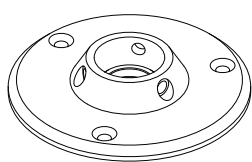

Flange Mount

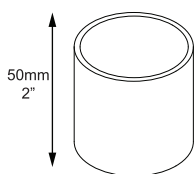

Snoot

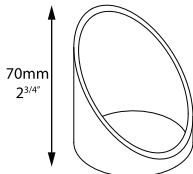

Glare Guard

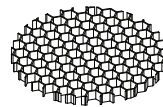

Hex Cell Louvre



Locking Knuckle

## BEAM ANGLES

High efficiency PMMA TIR lenses. Field replaceable

IES files available for download: [hunzalighting.com/downloads](http://hunzalighting.com/downloads)

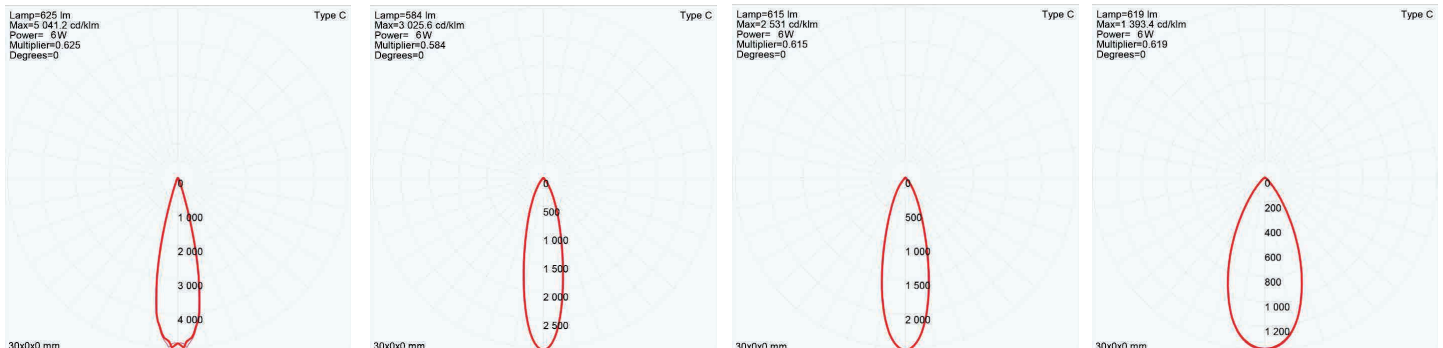

15° FWHM TIR

25° FWHM TIR

38° FWHM TIR

60° FWHM TIR

## WIRING GUIDE

Series/remote driver

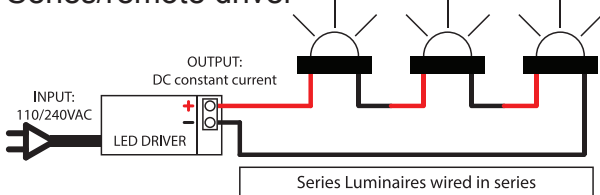

12v integral driver

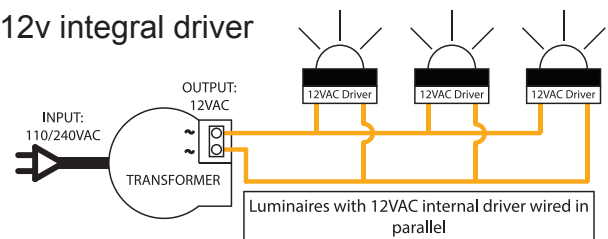

Available for download: [hunzalighting.com/downloads](http://hunzalighting.com/downloads)

Diagrams are a guide only, wire colours and polarity may change depending on fixture and country

Specifications may change without notification

Aug 2017