

Twin Border Lite

PROJECT:
TYPE:
SOURCE:
NOTES:

PURELED SPECIFICATIONS PER HEAD

LED Chip	Cree XPG-3 Plug and Play field replaceable LED board
Luminaire Output Per Head	120 Lumens @ 700mA (2 watts), delivered from luminaire with unobstructed beam.
Lumens Per Watt	60 Lumens minimum @ 2 watts, delivered from luminaire with unobstructed beam.
CRI (3000K)	90+
Colour Temperatures	2700K, 3000K, 4000K
Beam Angles	100 degrees
Ingress Protection	IP56/IP66

Warranty	Electronics = 5 years Body Cop/SS = 10 years Body Aluminium = 5 years
Standards	AS/NZS 61046 cUL 1838, 2108 CSA C22.2 No.250.7, No.250.0-08 CE

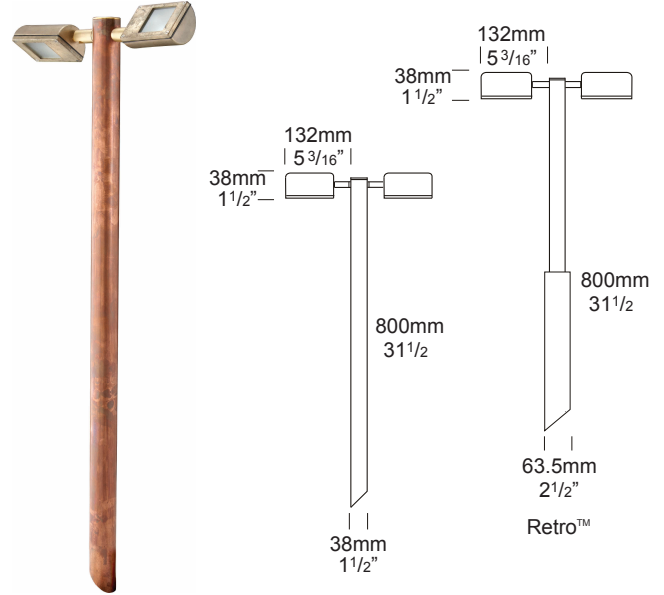

PRODUCT CONFIGURATION

Please fill in appropriate codes into boxes provided

Cat. No. BLT/L

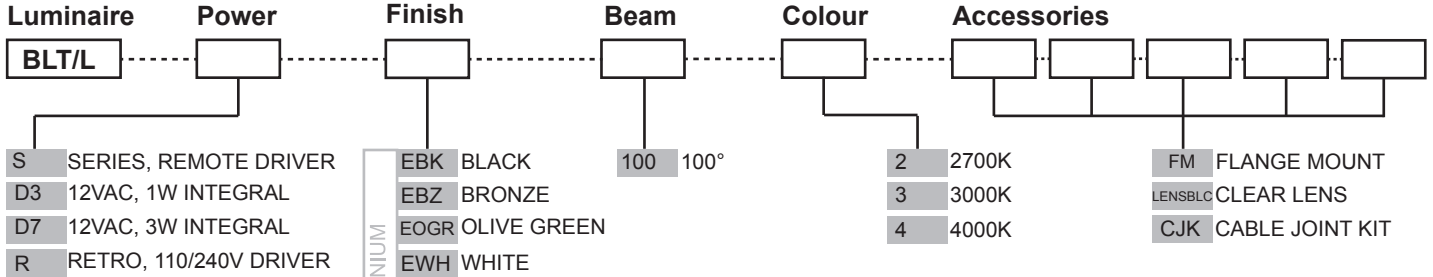

SERIES, REMOTE DRIVER REQUIRED:
Constant current driver
Individual fixtures require 3vdc @ 700mA maximum

12VAC INTEGRAL DRIVER:
Hunza Buckbullet driver (included)
Input: 12VAC, 6 watt total
Output: 3vdc @ D3=350mA, D7=700mA

110/240VAC RETRO DRIVER:
Input: 120/240vac, 6 watt total (included)
Output: 6vdc, 700mA
0-10 volt dimming
(USA - non dimming)

OTHER LAMP OPTIONS:
BLT/H - G4 Halogen 12V Lamp
BLT/GL - G4 LED Retrofit 12V Lamp (lamps vary by market - please refer to supplier for details)

[Click for here Remote Power Supply Guidance Charts](#)

[Click here for halogen specification sheet](#)

LUMINAIRE CONSTRUCTION

CNC machined from one of the following metals:

Aluminium

Head: virgin high corrosion resistant CC401 low copper aluminium alloy, with chromate substrate and high UV resistant polyester powder coat.

Pole: aluminium 38mm (1½") tube.

Colours:

Black, Bronze, Silver Star, White, White Birch, Olive Green, Dark Grey, Corten.

Copper/Solid Bronze

Head: cast from LG2 bronze.

Pole: solid copper 38mm (1½") tube.

316 Stainless Steel

Head: cast from 316 stainless steel.

Pole: stainless steel 38mm (1½") tube.

Knuckles:

Aluminium and Copper luminaires - 360° rotation and 0-90° elevation, solid brass with anti rust spring.

Stainless Steel luminaires - 360° rotation and 0-90° elevation, full stainless steel construction.

Lens:

3mm frosted shatter resistant glass.

Lifetime Warranty.

Gaskets:

Silicone, 220°C (428°F).

Mounting

The pole 800mm (31½") is directly mounted into the earth or concrete.

Flange Mount option is available for hard surfaces.

Luminaire Weight:

Low voltage

Alum: 1.100kg (2lb 6oz)

Cop/SBZ: 2.700kg (5lb 15oz)

SS: 2.400kg (5lb 4oz)

Retro™

Alum: 2.400kg (5lb 4oz)

Cop/SBZ: 4.200kg (9lb 4oz)

SS: 3.700kg (8lb 2oz)

ACCESSORIES

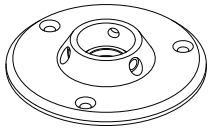

Flange Mount
FM38 for low voltage
FM90 for Retro

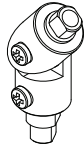

Locking Knuckle

BEAM ANGLES

IES files available for download: hunzalighting.com/downloads

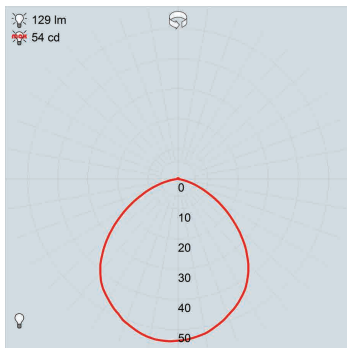

FWHM
frosted lens

WIRING GUIDE

Series/remote driver

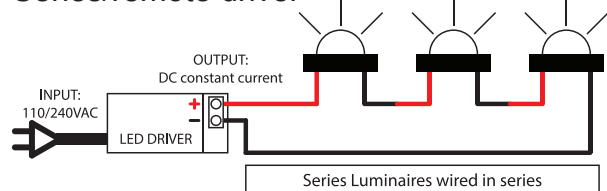

Diagrams are a guide only, wire colours and polarity may change depending on fixture and country

Available for download: hunzalighting.com/downloads

12v integral driver

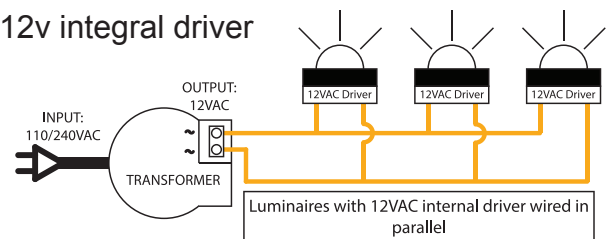

Specifications may change without notification

Aug 2017