

Ultra 35 Liquid Beam™ Pole Spot Light - Tunable White

INTELLIGENT LUMINAIRE

SPECIFICATIONS



LED Chip	Liquid Beam Tunable White LED
Luminaire Output	600 total Lumens all colours on, delivered from the Luminaire with unobstructed beam
Lumens Per Watt	80 Lumens @ 7.5 watts, delivered from Luminaire with unobstructed beam
CRI	80 Standard, 90 Available
Colour Temperatures	2700K - 5700K Tunable White
Beam Angles	Liquid Beam™ Technology Solid State Control 10 to 50 Deg
Ingress Protection	IP66

Warranty	Electronics = 5 years Body Aluminium = 5 years
Standards	BS/EN 60598.2.2 cUL 2108 CE

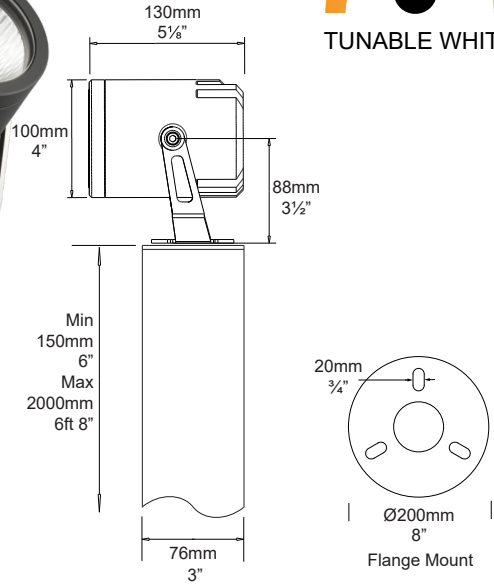

CASAMBI + Smart Lighting Bluetooth Ecosystem

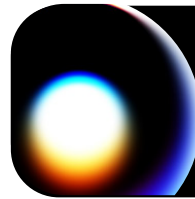

Liquid Beam™

A Solid State Light Beam controlled via Bluetooth, adjustable between 10-50 degrees. No need to service the fixture to adjust the beam.

PRODUCT CONFIGURATION

Please fill in appropriate codes into boxes provided

Cat. No. PS/U35/LBTW

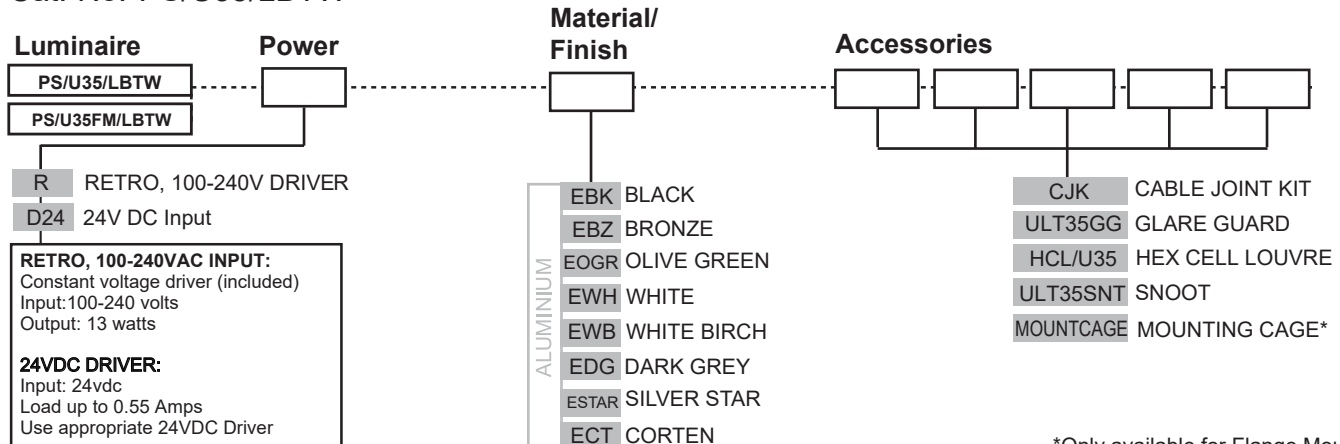

*Only available for Flange Mount Version

ADDITIONAL COMMENTS:

Full colour temperature control with Casambi. Bluetooth Mesh enabled via CASAMBI (free to download Lighting Control App) 10-50 Degree beam angle control with Liquid Beam™ Solid State Control. No external control gear required.

LUMINAIRE CONSTRUCTION

CNC machined from one of the following metals:

Aluminium:

Body: 101mm (4") high corrosion resistant aluminium rod with chromate substrate and high UV resistant polyester powder coat.
 Pole: 76mm (3") aluminium tube.
 Colours: Black, Bronze, Silver Star, White, White Birch, Olive Green, Dark Grey, Corten.

316 Stainless Steel:

Bracket: laser cut and folded 316 stainless steel.

Adjustability:

The fully adjustable head allows 360 degree rotation and 0-120 degree elevation.

Cable:

Water resistant rubber.

Gaskets:

Silicone, iron impregnated 220°C (428°F).

Step Lens:

12mm (1/2") extra clear, low iron, shatter resistant glass.
 Lifetime warranty.

Mounting:

The pole is cast into concrete or mounted via flange mount - please refer to the Hunza website for mounting instructions.

Luminaire Weight:

4kg (9lb)

ACCESSORIES

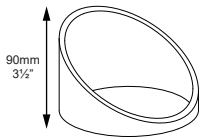

Glare Guard

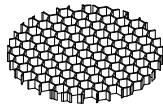

Hex Cell Louvre

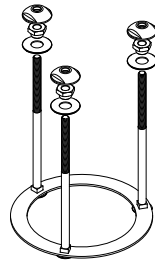

Mounting Cage

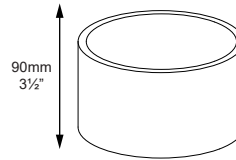

Snoot

BEAM ANGLES: Controlled with Liquid Beam™ Technology

Solid State Beam control Via Bluetooth Casambi App

IES files available for download: <http://www.hunzalighting.com/download.php>

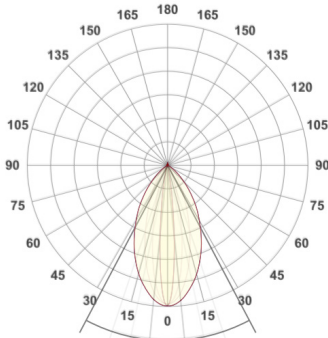

10° 3648° 50°

Adjustable between 10° to 50°

WIRING GUIDE

Available for download: www.hunzalighting.com/download.php

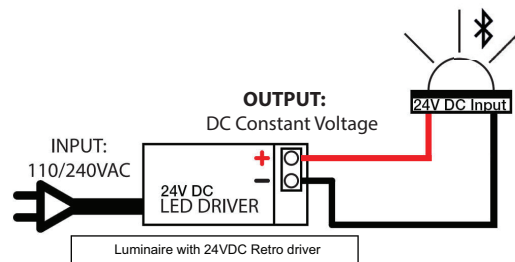
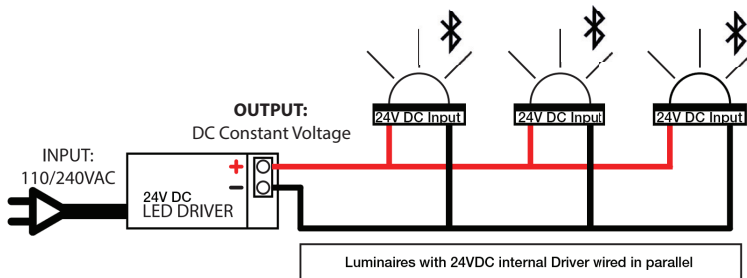

Try CASAMBI Smart Light Demo
 Free to Download on IOS or Android



Specifications may change without notification

Oct 2021 V1