

Floor Lite Louvre Square

PROJECT:

TYPE:

SOURCE:

NOTES:

PURELED SPECIFICATIONS

LED Chip	Cree XHP-50-2 Plug and Play field replaceable LED board
Luminaire Output	600 Lumens @ 1050mA (6 watts), 420 Lumens @ 700mA (4 watts), 240 Lumens @ 350mA (2 watts), delivered from luminaire with unobstructed beam.
Lumens Per Watt	100 Lumens @ 6 watts minimum, delivered from luminaire with unobstructed beam
CRI (3000K)	90+
Colour Temperatures	2700K, 3000K, 4000K
Beam Angles	15, 25, 38, 60
Ingress Protection	IP67
Warranty	Electronics = 5 years Body Cop/SS = 10 years
Standards	AS/NZS 61046 cUL 1838, 2108 CSA C22.2 No.250.7, No.250.0-08 CE

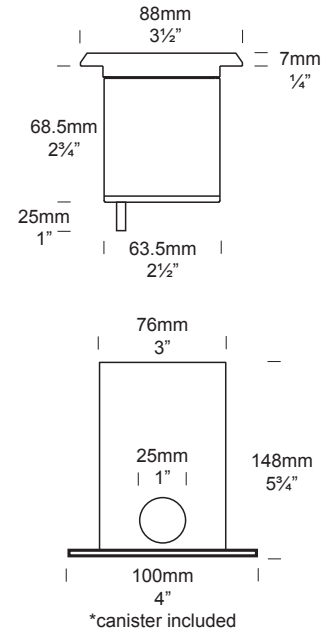

PRODUCT CONFIGURATION

Please fill in appropriate codes into boxes provided

Cat. No. FLLUSQ/L

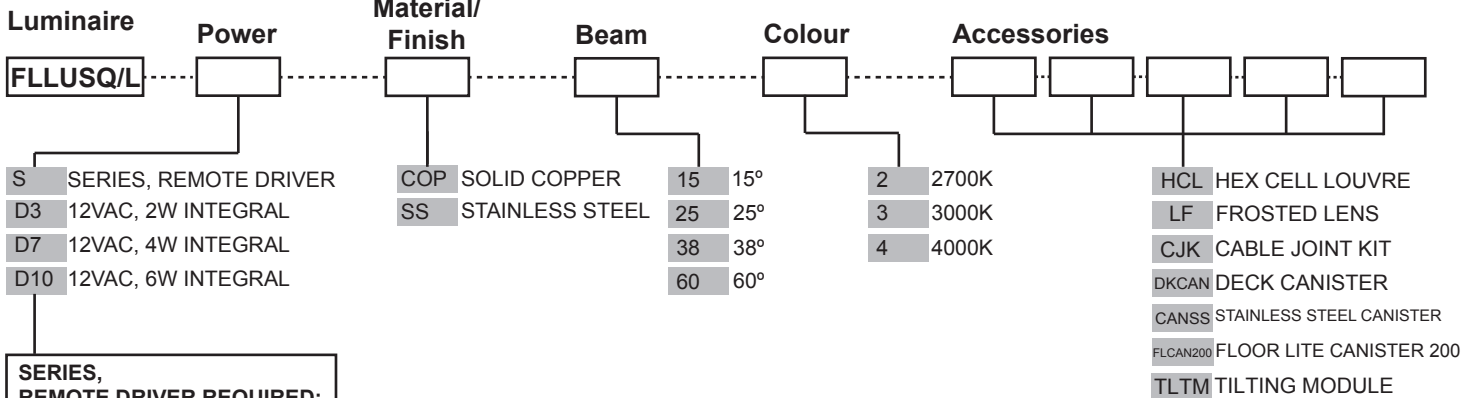

SERIES, REMOTE DRIVER REQUIRED:
Constant current driver
Individual fixtures require 6vdc @ 1050mA maximum

12VAC INTEGRAL DRIVER:
Hunza integrated plug and play driver (included)
Input: 9-15VAC.
Output: 6vdc @ D3=350mA, D7=700mA, D10=1050mA (1050mA limited to ≤ 40°C (104°F) ambient temperature in stainless steel)

OTHER LAMP OPTIONS:
FLLUSQ/H - MR16 Halogen 12V Lamp
FLLUSQ/SL - MR16 LED Retrofit 12V Lamp (lamps vary by market - please refer to supplier for details)
FLLUSQ/GUH - GU10 120/240V Halogen Lamp (body length increases for all GU10 lamps) FLSPSQ/GUSL or
FLLUSQ/GUSL - GU10 LED Retrofit 120/240V Lamp (lamps vary by market - please refer to supplier for details)

[Click here for halogen specification sheet](#)

[Click here for 240v Remote Power Supply Guidance Charts](#)
[Click here for USA Remote Power Supply Guidance Charts](#)

LUMINAIRE CONSTRUCTION

CNC machined from one of the following

metals:

Copper

Body: 63.5mm (2^{1/2}") x 9mm (3/8").

End cap: solid copper 63.5mm (2^{1/2}") rod.

Flange: solid copper 90mm x 90mm (3^{1/2}" x 3^{1/2}").

316 Stainless Steel

Body: solid 316 stainless steel 63.5mm (2^{1/2}") x 9mm (3/8").

End cap: solid 316 stainless steel 63.5 (2^{1/2}") rod.

Flange: 316 stainless steel 90mm x 90mm (3^{1/2}" x 3^{1/2}").

Lens:

10mm (3/8") extra clear low iron flush fit shatter resistant glass.

Lifetime warranty.

Gaskets:

Silicone, iron impregnated 220°C (428°F)

Mounting:

The luminaire is pushed into the canister and is held by two silicone "O" rings.

CANSS, FLCAN200: cast into concrete, concrete block, brick, etc.

DKCAN: mounted into wooden decks, wooden frames, etc.

Luminaire Weight:

Cop: 1.300kg (2lb 14oz)

SS: 1.175kg (2lb 9oz)

ACCESSORIES

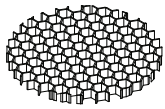

Hex Cell Louvre

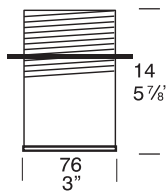

Deck Canister

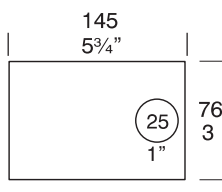

Stainless Steel Canister

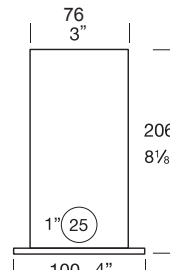

Floor Canister 200

BEAM ANGLES

High efficiency PMMA TIR lenses. Field replaceable

IES files available for download: hunzalighting.com/downloads

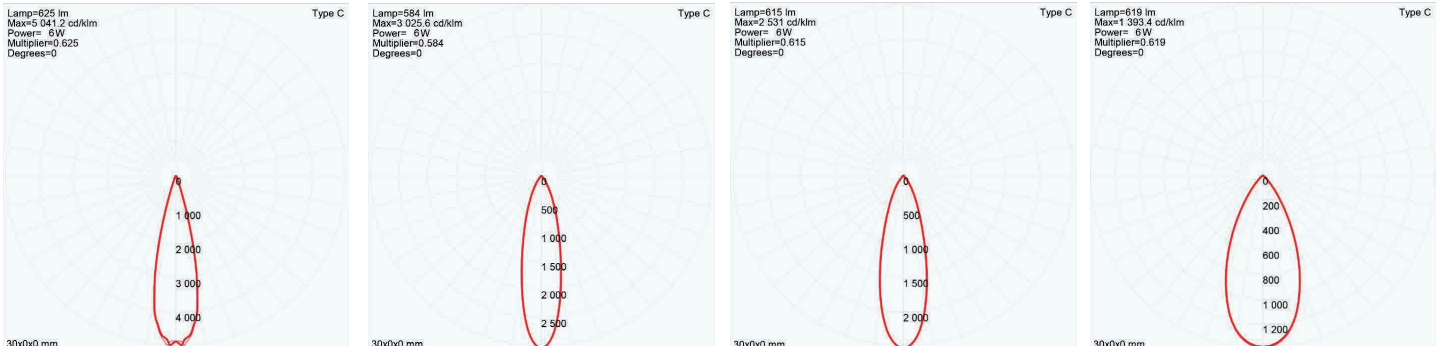

WIRING GUIDE

Series/remote driver

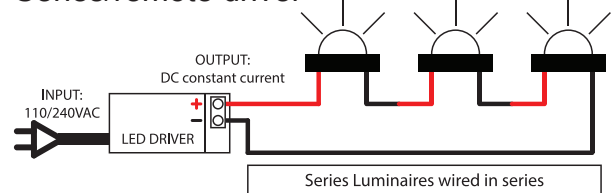

Diagrams are a guide only, wire colours and polarity may change depending on fixture and country

Available for download: hunzalighting.com/downloads

12v integral driver

